

# SAVK

*Karanlıktan Savk'a*



2026  
FIYAT LİSTESİ

## Armatürler

2-37



## Lambalar

40-49



## Bantlar

52-53



## Şerit Ledler

56-61

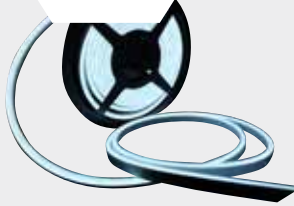
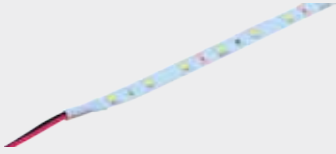

## Özel Lambalar

64-74



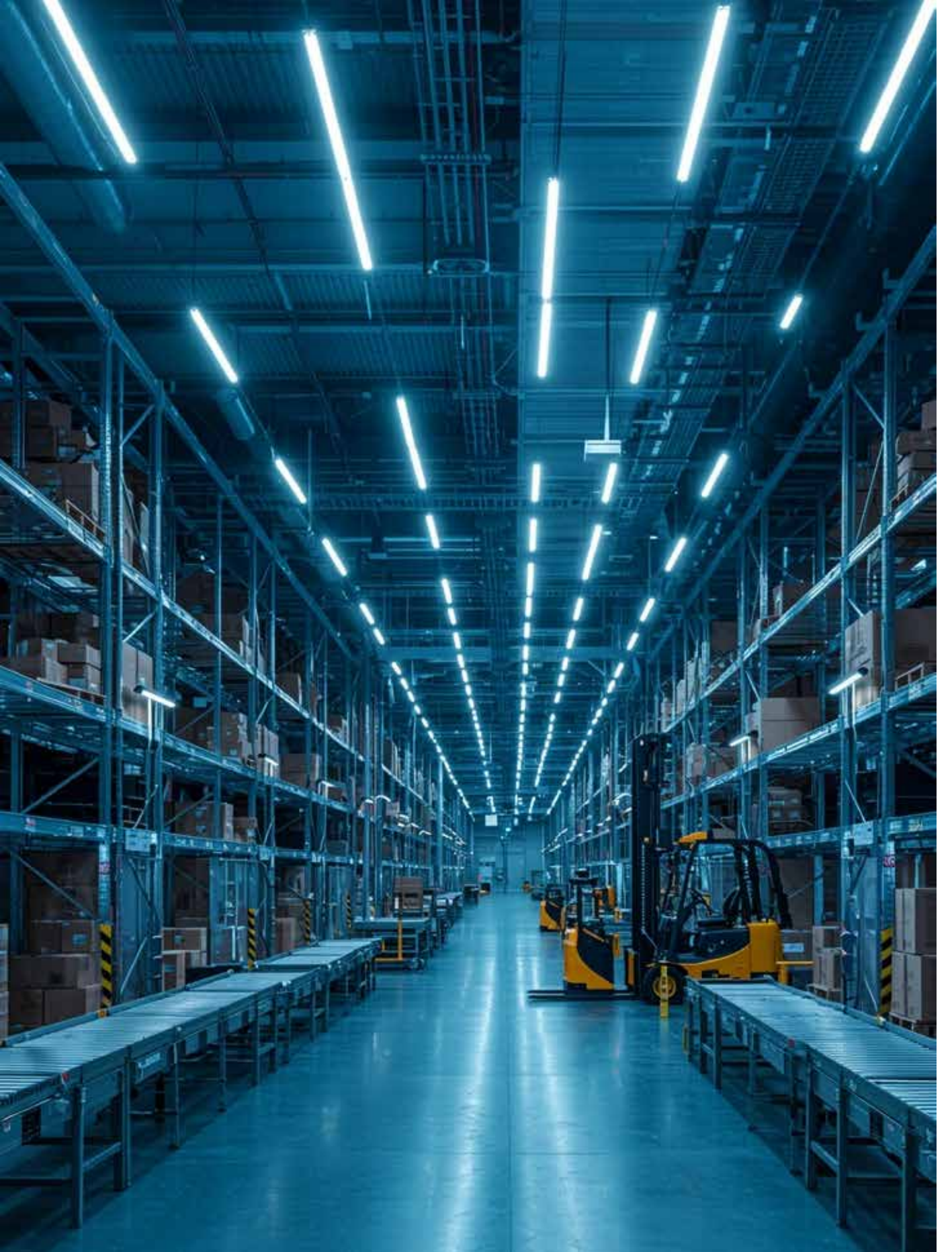

## ETANJ ARMATÜRLER / TSE'Lİ

ENEC  
SÜRÜCÜLÜ  
PHILIPS  
SÜRÜCÜ

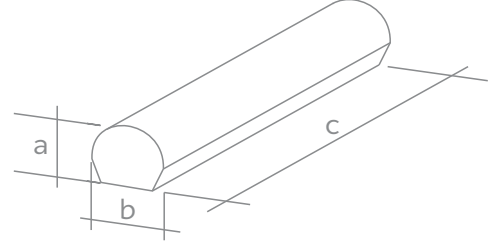

IP 65



50.000 Saat



Anında



≥ 80



Dimmable



IR UV



Hg



□

Sip. Kodu	Güç (W)	Işık Akısı (lm)	Renk Sıcaklığı (K)	Ölçüler (a/b/c)	Koli Adedi	Fiyat (\$)
760250	18	1800	3000	60/50/600	6	23,00
760251	18	1800	4000	60/50/600	6	23,00
760252	18	1800	6500	60/50/600	6	23,00
760260	36	3600	3000	60/50/1200	6	32,30
760261	36	3600	4000	60/50/1200	6	32,30
760262	36	3600	6500	60/50/1200	6	32,30
760360	44	4400	3000	60/50/1200	6	33,92
760361	44	4400	4000	60/50/1200	6	33,92
760362	44	4400	6500	60/50/1200	6	33,92
760270	65	6500	3000	60/50/1500	6	43,50
760271	65	6500	4000	60/50/1500	6	43,50
760272	65	6500	6500	60/50/1500	6	43,50

### Yüksek Güçlü

760540	95	9500	3000	60/50/1500	6	56,00
760541	95	9500	4000	60/50/1500	6	56,00
760542	95	9500	6500	60/50/1500	6	56,00

## ACİL KİT VE RADAR SENSÖRLÜ ETANJ ARMATÜRLER/ TSE'Lİ

ENEC  
SÜRÜCÜLÜ

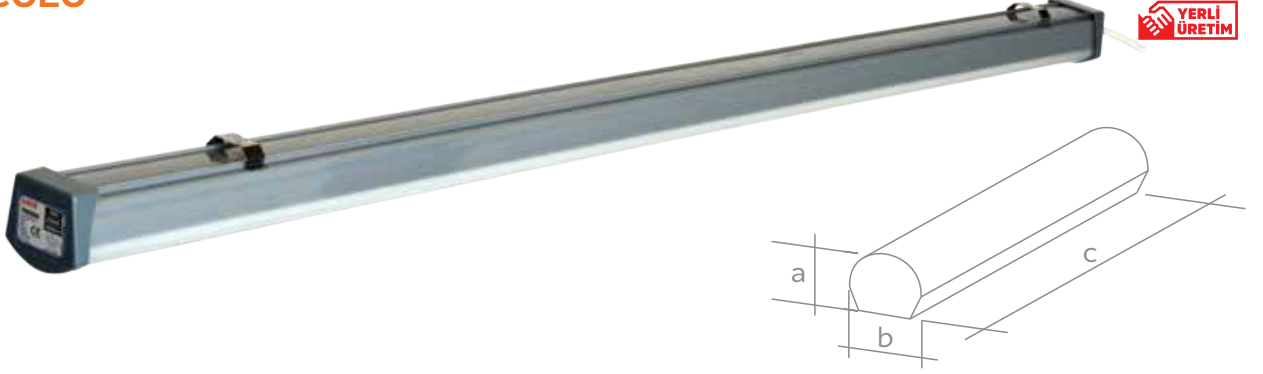

IP 65



Sip. Kodu	Güç (W)	Işık Akısı (lm)	Renk Sıcaklığı (K)	Ölçüler (a/b/c)	Koli Adedi	Fiyat (\$)
760290	36	3600	3000	60/50/1200	6	75,00
760291	36	3600	4000	60/50/1200	6	75,00
760292	36	3600	6500	60/50/1200	6	75,00
760300	65	6500	3000	60/50/1500	6	79,00
760301	65	6500	4000	60/50/1500	6	79,00
760302	65	6500	6500	60/50/1500	6	79,00

### Radar Sensörlü, Dimli

760660	36	3600	3000	60/50/1200	6	60,60
760661	36	3600	4000	60/50/1200	6	60,60
760662	36	3600	6500	60/50/1200	6	60,60
760670	65	6500	3000	60/50/1500	6	72,64
760671	65	6500	4000	60/50/1500	6	72,64
760672	65	6500	6500	60/50/1500	6	72,64

### Radar Sensörlü, Dimli, Acil Kitli

760760	36	3600	3000	60/50/1200	6	100,00
760761	36	3600	4000	60/50/1200	6	100,00
760762	36	3600	6500	60/50/1200	6	100,00

## ETANJ ARMATÜRLER

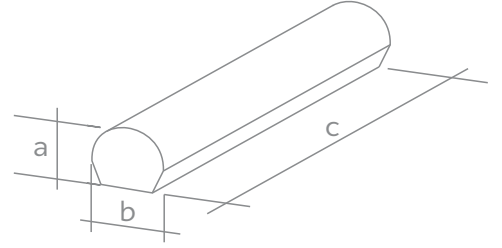

IP 65



50.000 Saat



Anında



≥ 80



Dimmable



IR+UV



Hg



□

Sip. Kodu	Güç (W)	Işık Akısı (lm)	Renk Sıcaklığı (K)	Ölçüler (a/b/c)	Koli Adedi	Fiyat (\$)
760247	18	-	Yeşil	60/50/600	6	17,60
760248	18	-	Mavi	60/50/600	6	17,60
760249	18	-	Amber	60/50/600	6	17,60
760263	36	-	Yeşil	60/50/1200	6	25,00
760264	36	-	Mavi	60/50/1200	6	25,00
760265	36	-	Amber	60/50/1200	6	25,00
760860	40	4000	3000	60/50/1200	6	23,00
760861	40	4000	4000	60/50/1200	6	23,00
760862	40	4000	6500	60/50/1200	6	23,00

## ŞEFFAF ETANJ ARMATÜRLER/ TSE'Lİ

ENEC  
SÜRÜCÜLÜ  
PHILIPS  
SÜRÜCÜ

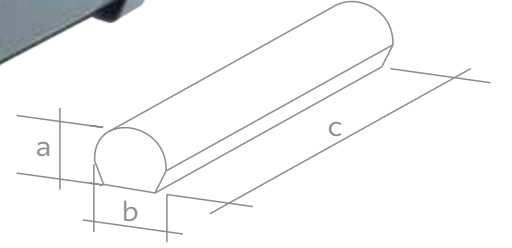

IP 65



Sip. Kodu	Güç (W)	Işık Akısı (lm)	Renk Sıcaklığı (K)	Ölçüler (a/b/c)	Koli Adedi	Fiyat (\$)
760310	18	2250	3000	60/50/600	6	24,00
760311	18	2250	4000	60/50/600	6	24,00
760312	18	2250	6500	60/50/600	6	24,00
760320	36	4500	3000	60/50/1200	6	33,80
760321	36	4500	4000	60/50/1200	6	33,80
760322	36	4500	6500	60/50/1200	6	33,80
760460	44	5500	3000	60/50/1200	6	35,60
760461	44	5500	4000	60/50/1200	6	35,60
760462	44	5500	6500	60/50/1200	6	35,60
760330	65	8125	3000	60/50/1500	6	45,60
760331	65	8125	4000	60/50/1500	6	45,60
760332	65	8125	6500	60/50/1500	6	45,60

## YÜKSEK TAVAN ARMATÜRLERİ

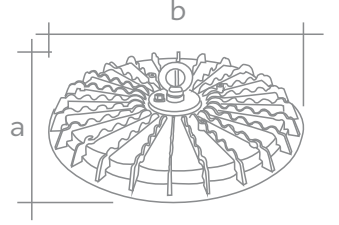

IP 65



IK 05



Sip. Kodu	Güç (W)	Işık Akısı (lm)	Renk Sıcaklığı (K)	Ölçüler (a/b)	Koli Adedi	Fiyat (\$)
750822	100	11000	6500	35/245	1	59,60
750832	150	16500	6500	35/280	1	76,60
750842	200	22000	6500	35/330	1	96,00

2 Yıl Garantili

## SÜRÜCÜLÜ YÜKSEK TAVAN ARMATÜRLERİ

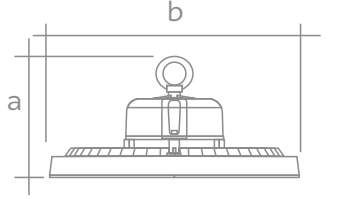

IP 65



IK 05



Sip. Kodu	Güç (W)	Işık Akısı (lm)	Renk Sıcaklığı (K)	Ölçüler (a/b)	Koli Adedi	Fiyat (\$)
750622	100	11000	6500	75/245	1	66,70
750632	150	16500	6500	75/280	1	100,00

2 Yıl Garantili

### Enec Sürücülü

750722	100	11000	6500	75/245	1	98,60
750732	150	16500	6500	75/280	1	134,00
750742	200	22000	6500	75/330	1	152,00

3 Yıl Garantili

## AYARLI YÜKSEK TAVAN ARMATÜRÜ

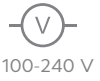
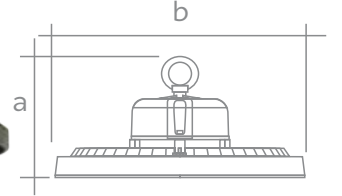
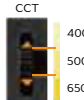
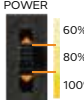

IP 65



IK 08



Sip. Kodu	Güç (W)	Işık Akısı (lm)	Renk Sıcaklığı (K)	Ölçüler (a/b)	Koli Adedi	Fiyat (\$)
750342	240	31200	4000/5000/6500	157,8/320	1	-
750342	200	26000	4000/5000/6500	157,8/320	1	-
750342	150	19500	4000/5000/6500	157,8/320	1	-

## DOĞRUSAL YÜKSEK TAVAN ARMATÜRÜ

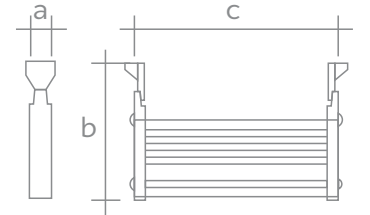

IP 65



IK 05



Sip. Kodu	Güç (W)	Işık Akısı (lm)	Renk Sıcaklığı (K)	Ölçüler (a/b)	Koli Adedi	Fiyat (\$)
770052	150	16500	6500	60/180/1200	1	270,00
770054	72	7920	6500	60/180/1200	1	243,60



## PROJEKTÖRLER



Sensörlü

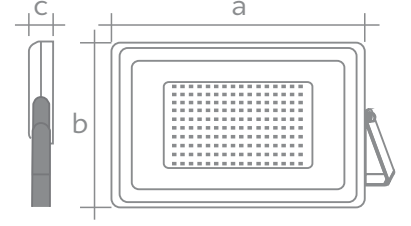

IP 65



IK 06



Sip. Kodu	Güç (W)	Işık Akısı (lm)	Renk Sıcaklığı (K)	Ölçüler (a/b/c)	Koli Adedi	Fiyat (\$)
750400	10	1000	3000	98/80/28	30	11,50
750402	10	1000	6500	98/80/28	30	11,50
750403	10	-	Yeşil	98/80/28	30	12,00
750404	10	-	Amber	98/80/28	30	12,50
750405	10	-	RGB	98/80/28	30	26,00
750410	30	3000	3000	148/133/28	30	19,00
750412	30	3000	6500	148/133/28	30	19,00
750413	30	-	Yeşil	148/133/28	30	21,00
750414	30	-	Amber	148/133/28	30	21,50
750430	50	5500	3000	178/170/28	20	24,80
750432	50	5500	6500	178/170/28	20	24,80
750435	50	-	Yeşil	178/170/28	20	26,20
750450	100	11450	3000	250/250/30	10	38,50
750452	100	11450	6500	250/250/30	10	38,50
750460	150	16000	3000	330/275/35	5	70,00
750462	150	16000	6500	330/275/35	5	70,00
750470	200	20400	3000	390/310/35	5	85,20
750472	200	20400	6500	390/310/35	5	85,20
750474	200	-	Amber	390/310/35	5	89,46
750490	300	30000	3000	421/307/45	3	172,00
750492	300	30000	6500	421/307/45	3	172,00
750591	400	40000	4000	460/340/50	2	245,00
750592	400	40000	6500	460/340/50	2	245,00

Sensörlü

750442	30	3000	6500	178/133/28	20	30,47
--------	----	------	------	------------	----	-------

## WALLWASHER

Ventil Yok  
Çünkü Gerek yok



Özelleştirilebilir  
Dekoratif Renk Bandı



20 Mikron Eloksal Kaplama ile  
Zorlu Doğa Koşullarına Karşı  
Yüksek Dayanım



Rekorsuz Kablo Girişliyle  
220V IP 67  
24V DC IP 68 (2mt)  
Sızdırmazlık



Özel Taptite  
Üçgen Vida



Yoğuşma  
Önleyici Materyal



Yüksek Kalite  
Led, Driver ve Lens



## WALLWASHERLAR

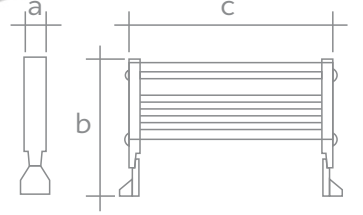

IP 67



IK 06



Sip. Kodu	Güç (W)	Işık Açısı	Işık Akısı (lm)	Renk Sıcaklığı (K)	Ölçüler (a/b/c)	Fiyat (\$)
<b>15 CM</b>						
770110	11	30	880	3000	60/180/150	73,96
770112	11	30	880	6500	60/180/150	73,96
770113	9	30	-	Kırmızı	60/180/150	78,26
770114	11	30	-	Mavi	60/180/150	78,26
770115	11	30	-	Yeşil	60/180/150	78,26
770116	9	30	-	Amber	60/180/150	78,26
<b>30 CM</b>						
770140	20	30	1900	3000	60/180/300	100,15
770142	20	30	1900	6500	60/180/300	100,15
770143	16	30	-	Kırmızı	60/180/300	105,60
770144	20	30	-	Mavi	60/180/300	105,60
770145	20	30	-	Yeşil	60/180/300	105,60
770146	16	30	-	Amber	60/180/300	105,60
<b>60 CM</b>						
770170	38	30	3600	3000	60/180/600	140,21
770172	38	30	3600	6500	60/180/600	140,21
770173	30	30	-	Kırmızı	60/180/600	154,32
770174	38	30	-	Mavi	60/180/600	154,32
770175	38	30	-	Yeşil	60/180/600	154,32
770176	30	30	-	Amber	60/180/600	154,32
<b>105 CM</b>						
770230	64	30	6250	3000	60/180/1050	209,55
770232	64	30	6250	6500	60/180/1050	209,55
770233	52	30	-	Kırmızı	60/180/1050	227,49
770234	64	30	-	Mavi	60/180/1050	227,49
770235	64	30	-	Yeşil	60/180/1050	227,49
770236	52	30	-	Amber	60/180/1050	227,49

## 12V | 48V WALLWASHERLAR

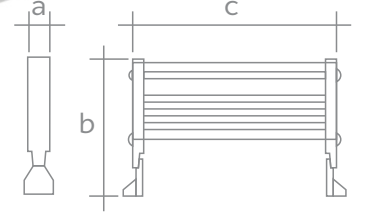

IP 67



50.000 Saat



Anında



≥ 80



Dimmable



IRUV



Hg

IK 06



Sip. Kodu	Güç (W)	Işık Açısı	Işık Akısı (lm)	Renk Sıcaklığı (K)	Ölçüler (a/b/c)	Fiyat (\$)
<b>12-24 V / 15 cm</b>						
780110	11	30	880	3000	60/180/150	84,74
780112	11	30	880	6500	60/180/150	84,74
780113	9	30	-	Kırmızı	60/180/150	90,07
780114	11	30	-	Mavi	60/180/150	90,07
780115	11	30	-	Yeşil	60/180/150	90,07
780116	9	30	-	Amber	60/180/150	90,07
<b>24-48 V / 30 cm</b>						
780140	20	30	1900	3000	60/180/300	115,56
780142	20	30	1900	6500	60/180/300	115,56
780143	16	30	-	Kırmızı	60/180/300	121,08
780144	20	30	-	Mavi	60/180/300	121,08
780145	20	30	-	Yeşil	60/180/300	121,08
780146	16	30	-	Amber	60/180/300	121,08

## SIVA ALTI WALLWASHER KASALARI

Sip. Kodu	Ölçüler (a/b/c)	Renk Sıcaklığı (K)	Fiyat (\$)
770300	224/145/93	Mat Krom	43,75
770301	374/146/93	Mat Krom	69,25
770302	669/146/93	Mat Krom	85,70
770304	1119/146/93	Mat Krom	127,50

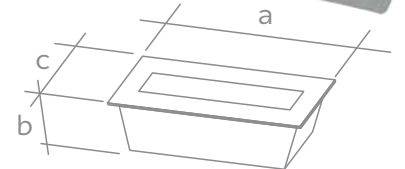

## TEK YÖNLÜ KÖŞELİ DUVAR ARMATÜRLERİ

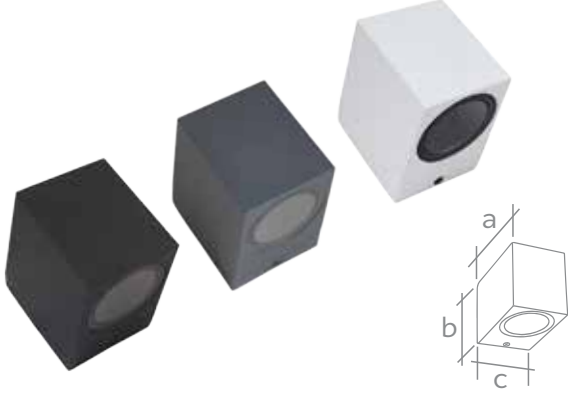

IP 54



GU10



Sip. Kodu	Kasa Rengi	Ölçüler (a/b/c)	Koli Adedi	Fiyat (\$)
702103	Siyah	92x80x65	48	18,72
702203	Antrasit	92x80x65	48	18,72
702403	Beyaz	92x80x65	48	18,72

## TEK YÖNLÜ OVAL DUVAR ARMATÜRLERİ



IP 54



GU10



Sip. Kodu	Kasa Rengi	Ölçüler (a/b/c)	Koli Adedi	Fiyat (\$)
702101	Siyah	92x80x65	48	17,68
702201	Antrasit	92x80x65	48	17,68
702401	Beyaz	92x80x65	48	17,68

## ÇİFT YÖNLÜ KÖŞELİ DUVAR ARMATÜRLERİ

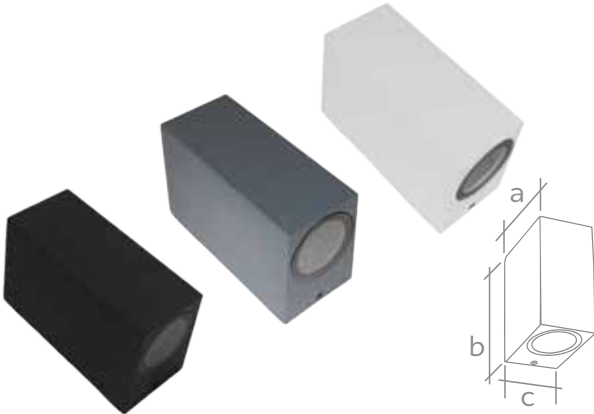

IP 54



2 x GU10



Sip. Kodu	Kasa Rengi	Ölçüler (a/b/c)	Koli Adedi	Fiyat (\$)
702104	Siyah	92x150x68	24	24,65
702204	Antrasit	92x150x68	24	24,65
702304	Beyaz	92x150x68	24	24,65

## ÇİFT YÖNLÜ SİLİNDİR DUVAR ARMATÜRLERİ

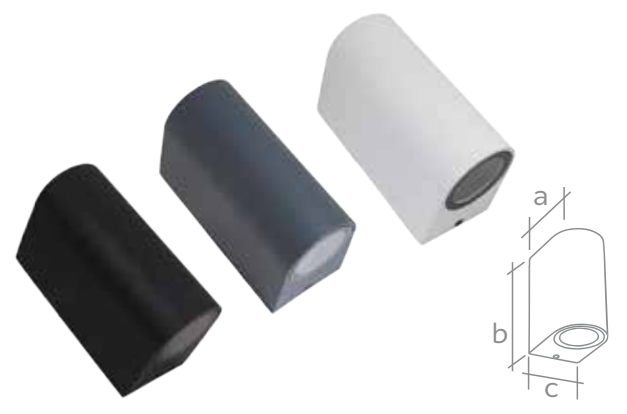

IP 54



2 x GU10



Sip. Kodu	Kasa Rengi	Ölçüler (a/b/c)	Koli Adedi	Fiyat (\$)
702102	Siyah	92x150x68	24	21,50
702202	Antrasit	92x150x68	24	21,50
702402	Beyaz	92x150x68	24	21,50

## IŞIK SÜZMELİ TEK YÖNLÜ OVAL DUVAR ARMATÜRLERİ

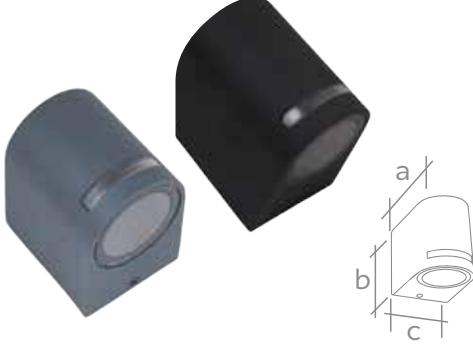

IP 54



GU10



Sip. Kodu	Kasa Rengi	Ölçüler (a/b/c)	Koli Adedi	Fiyat (\$)
702123	Siyah	92x80x65	48	19,59
702223	Antrasit	92x80x65	48	19,59

## IŞIK SÜZMELİ ÇİFT YÖNLÜ OVAL DUVAR ARMATÜRLERİ



IP 54



2 x GU10



Sip. Kodu	Kasa Rengi	Ölçüler (a/b/c)	Koli Adedi	Fiyat (\$)
702124	Siyah	92x150x68	24	25,61
702224	Antrasit	92x150x68	24	25,61
702424	Beyaz	92x150x68	24	25,61

## TEK YÖNLÜ SİLİNDİR DUVAR ARMATÜRLERİ



IP 54



GU10



Sip. Kodu	Kasa Rengi	Ölçüler (a/b/c)	Koli Adedi	Fiyat (\$)
701107	Siyah	92x120x68	48	23,70
701207	Antrasit	92x120x68	48	23,70
701307	Mat Saten	92x120x68	48	26,28

## TEK YÖNLÜ SİLİNDİR MAFSALLI DUVAR ARMATÜRLERİ



IP 54



GU10



Sip. Kodu	Kasa Rengi	Ölçüler (a/b/c)	Koli Adedi	Fiyat (\$)
701109	Siyah	92x120x68	48	26,76
701209	Antrasit	92x120x68	48	26,76
701309	Mat Saten	92x120x68	48	29,43

## BOMBELİ DUVAR ARMATÜRLERİ

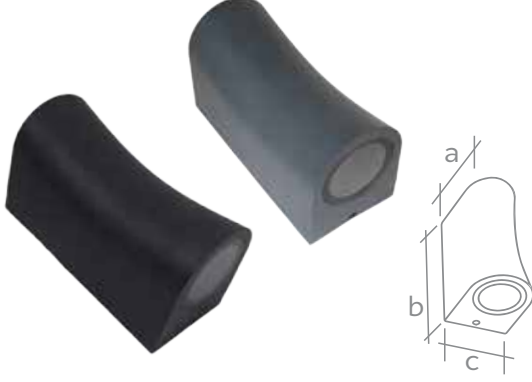

IP 54



GU10



Sip. Kodu	Kasa Rengi	Ölçüler (a/b/c)	Koli Adedi	Fiyat (\$)
701106	Siyah	100x180x84	24	29,43
702206	Antrasit	100x180x84	24	29,43

## ÇİFT YÖNLÜ SİLİNDİR ARMATÜRLERİ



IP 54



2 x GU10



Sip. Kodu	Kasa Rengi	Ölçüler (a/b/c)	Koli Adedi	Fiyat (\$)
702108	Siyah	92x180x68	24	27,14
702208	Antrasit	92x180x68	24	27,14
702308	Mat Saten	92x180x68	24	31,34

## OPAL DİFÜZÖRLÜ DUVAR ARMATÜRLERİ

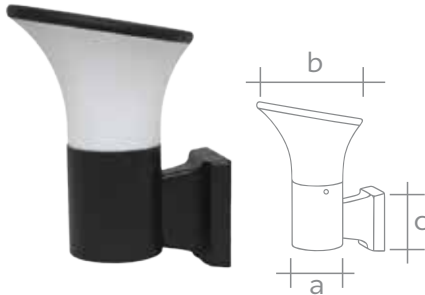

IP 65



E 27



Sip. Kodu	Kasa Rengi	Ölçüler (a/b/c)	Koli Adedi	Fiyat (\$)
702105	Siyah	90x170x105	8	65,46
702205	Antrasit	90x170x105	8	65,46

## BOLLARD ARMATÜRLERİ



IP 65



E 27



Sip. Kodu	Kasa Rengi	Ölçüler (a/b/c)	Koli Adedi	Fiyat (\$)
702180	Siyah	90x170x300	8	85,04
702181	Siyah	90x170x500	4	100,33
702182	Siyah	90x170x800	4	118,00
702280	Antrasit	90x170x300	8	85,04
702281	Antrasit	90x170x500	4	100,33
702282	Antrasit	90x170x800	4	118,00

## KAZIKLI ÇİM ARMATÜRLERİ



IP 54



GU10



Sip. Kodu	Kasa Rengi	Ölçüler (a/b/c)	Koli Adedi	Fiyat (\$)
701101	Siyah	95x270x90	24	18,16
701201	Antrasit	95x270x90	24	18,16

## ŞAPKALI KAZIKLI ÇİM ARMATÜRLERİ



IP 54



GU10



Sip. Kodu	Kasa Rengi	Ölçüler (a/b/c)	Koli Adedi	Fiyat (\$)
701302	Siyah	150x330x90	24	23,51
701301	Antrasit	150x330x90	24	23,51

## METAL KAZIKLI ÇİM ARMATÜRLERİ



IP 54



GU10



Sip. Kodu	Kasa Rengi	Ölçüler (a/b/c)	Koli Adedi	Fiyat (\$)
701402	Siyah	110x360x105	24	21,50
701401	Antrasit	110x360x105	24	21,50

## KAZIKLI ÇİM ARMATÜRÜ



IP 65



GU10



Sip. Kodu	Kasa Rengi	Ölçüler (a/b/c)	Koli Adedi	Fiyat (\$)
701601	Siyah	180x120x260	24	13,76

## PANEL ARMATÜRLER

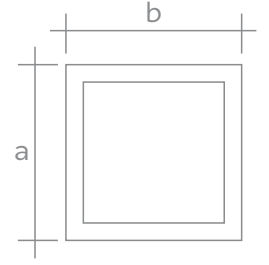

IP 40



Sip. Kodu	Güç (W)	Işık Akısı (lm)	Renk Sıcaklığı (K)	Ölçüler (a/b)	Koli Adedi	Yükseklik (c)	Fiyat (\$)
<b>Taşyünü / Sıva Altı</b>							
760489	48	4800	3000	60/60	8	4,5	25,60
760490	48	4800	4000	60/60	8	4,5	25,60
760491	48	4800	6500	60/60	8	4,5	25,60
<b>Alçıpan</b>							
760497	48	4800	3000	60/60	8	8	32,44
760498	48	4800	4000	60/60	8	8	32,44
760499	48	4800	6500	60/60	8	8	32,44
<b>Sıva Üstü</b>							
760493	48	4800	3000	60/60	8	5	-
760494	48	4800	4000	60/60	8	5	-
760495	48	4800	6500	60/60	8	5	-
<b>Sıva Altı</b>							
760253	12	1480	3000	30/30	40	3	8,80
760256	12	1480	6500	30/30	40	3	8,80

## ENEC SÜRÜCÜLÜ PANEL ARMATÜRLER

**PHILIPS**  
SÜRÜCÜ



3 Yıl  
Garanti

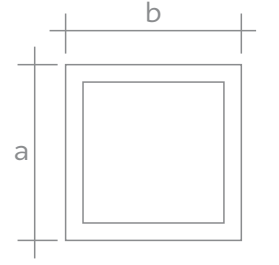

IP 40



Sip. Kodu	Güç (W)	Işık Akısı (lm)	Renk Sıcaklığı (K)	Ölçüler (a/b)	Koli Adedi	Yükseklik (c)	Fiyat (₺)
<b>Taşyünü / Sıva Altı</b>							
760471	48	4800	3000	60/60	8	4,5	32,00
760472	48	4800	4000	60/60	8	4,5	32,00
760473	48	4800	6500	60/60	8	4,5	32,00
<b>Alçıpan</b>							
760479	48	4800	3000	60/60	8	8	38,84
760480	48	4800	4000	60/60	8	8	38,84
760481	48	4800	6500	60/60	8	8	38,84
<b>Sıva Üstü</b>							
760475	48	4800	3000	60/60	8	5	-
760476	48	4800	4000	60/60	8	5	-
760477	48	4800	6500	60/60	8	5	-

## PANEL KASALARI

Sip. Kodu	Ölçüler (a/b)	Yükseklik (c)	Fiyat (₺)
<b>Sıva Üstü</b>			
710700	30/30	5	4,80
710760	60/60	5	13,40
710775	60/60	8	24,40
<b>Clip-in</b>			
710710	30/30	2,5	5,28
710770	60/60	2,5	16,40
<b>Alçıpan Yay Takımı</b>			
710765	30*30 ve 60*60 uyumludur		1,90

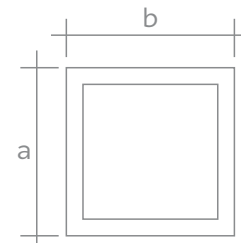

## SENSÖRLÜ LED TAVAN ARMATÜRLERİ

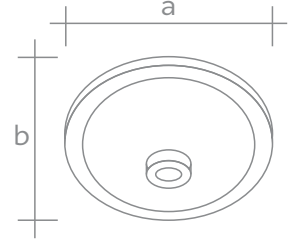

IP 40



25.000 Saat



Anında



≥ 80



Dimmable



UV



Hg



Sip. Kodu	Güç (W)	Işık Akısı (lm)	Renk Sıcaklığı (K)	Ölçüler (a/b)	Koli Adedi	Fiyat (\$)
702186	18	2200	6500	300/95	10	15,20
<b>Acil Kitli</b>						
712186	18	2200	6500	300/95	10	20,34

## DÜĞMELİ CAM LED TAVAN ARMATÜRÜ

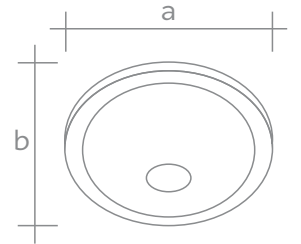

IP 40



25.000 Saat



Anında



≥ 80



Dimmable



UV



Hg



Sip. Kodu	Güç (W)	Işık Akısı (lm)	Renk Sıcaklığı (K)	Ölçüler (a/b)	Koli Adedi	Fiyat (\$)
702196	18	2200	6500	300/95	10	17,10

## HAREKET SENSÖRLÜ CAM LED TAVAN ARMATÜRÜ

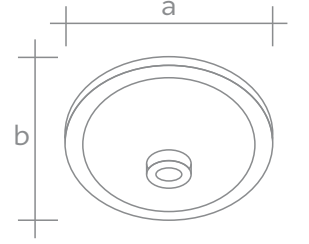

IP 40



Sip. Kodu	Duy	Ölçüler (a/b)	Koli Adedi	Fiyat (\$)
702191	2 x E27	300/95	10	13,80

## LED TAVAN ARMATÜRÜ

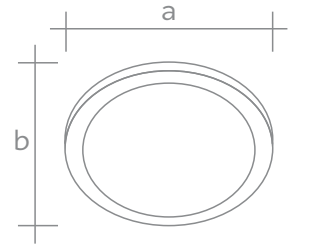

IP 40



Sip. Kodu	Güç (W)	Işık Akısı (lm)	Renk Sıcaklığı (K)	Ölçüler (a/b)	Koli Adedi	Fiyat (\$)
702194	22	1700	6500	300/95	10	10,47

## SIVA ÜSTÜ KARE PANEL ARMATÜRLER

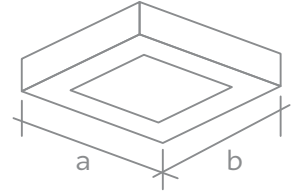

IP 20



Sip. Kodu	Güç (W)	Işık Akısı (lm)	Kasa Rengi	Renk Sıcaklığı (K)	Yükseklik (cm)	Ölçüler (a/b)	Koli Adedi	Fiyat (\$)
710233	18	1620	Beyaz	3000	2.4	225/225	20	8,80
710236	18	1620	Beyaz	6500	2.4	225/225	20	8,80
710243	24	1920	Beyaz	3000	2.4	300/300	10	16,54
710246	24	1920	Beyaz	6500	2.4	300/300	10	16,54

## SIVA ÜSTÜ YUVARLAK PANEL ARMATÜRLER

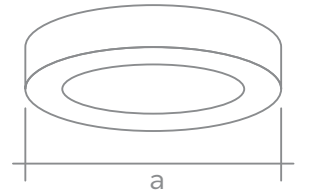

IP 20



Sip. Kodu	Güç (W)	Işık Akısı (lm)	Kasa Rengi	Renk Sıcaklığı (K)	Yükseklik (cm)	Ölçüler (a)	Koli Adedi	Fiyat (\$)
711223	18	1620	Beyaz	3000	2.4	225	30	9,85
711226	18	1620	Beyaz	6500	2.4	225	30	9,85
711243	24	1920	Beyaz	3000	2.4	300	10	13,38
711246	24	1920	Beyaz	6500	2.4	300	10	13,38

## SIVA ALTI PANEL ARMATÜRLER

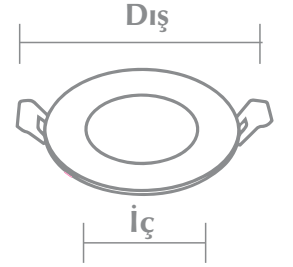

IP 20



Sip. Kodu	Güç (W)	Işık Akısı (lm)	Renk Sıcaklığı (K)	İç Çap (mm)	Dış Çap (mm)	Koli Adedi	Fiyat (\$)
710033	3	270	3000	73	85	100	3,10
710034	3	270	4000	73	85	100	3,10
710036	3	270	6500	73	85	100	3,10
710063	6	540	3000	110	120	100	4,00
710064	6	540	4000	110	120	100	4,00
710066	6	540	6500	110	120	100	4,00
710093	9	810	3000	135	145	60	4,89
710094	9	810	4000	135	145	60	4,89
710096	9	810	6500	135	145	60	4,89
710123	12	1080	3000	160	174	40	5,76
710124	12	1080	4000	160	174	40	5,76
710126	12	1080	6500	160	174	40	5,76
710153	15	1350	3000	185	200	40	6,51
710154	15	1350	4000	185	200	40	6,51
710156	15	1350	6500	185	200	40	6,51
710183	18	1620	3000	205	220	20	7,17
710184	18	1620	4000	205	220	20	7,17
710186	18	1620	6500	205	220	20	7,17

## YATAY LED BANT ARMATÜRLER

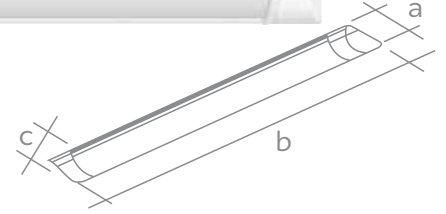

IP 40



Sip. Kodu	Güç (W)	Işık Akısı (lm)	Renk Sıcaklığı (K)	Ölçüler (a/b/c)	Koli Adedi	Fiyat (\$)
710213	23	2400	3000	73/662/24	30	10,80
710214	23	2400	4000	73/662/24	30	10,80
710215	23	2400	6500	73/662/24	30	10,80
710220	42	5100	3000	73/1270/24	30	15,54
710221	42	5100	4000	73/1270/24	30	15,54
710222	42	5100	6500	73/1270/24	30	15,54

## T5 LED BANT ARMATÜRLER

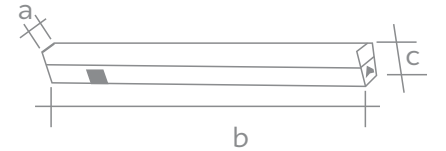

IP 40



Sip. Kodu	Güç (W)	Işık Akısı (lm)	Renk Sıcaklığı (K)	Ölçüler (a/b/c)	Koli Adedi	Fiyat (\$)
710411	9	900	3000	22/600/32	25	7,48
710412	9	900	4000	22/600/32	25	7,48
710413	9	900	6500	22/600/32	25	7,48
710414	18	1800	3000	22/1200/32	25	11,36
710415	18	1800	4000	22/1200/32	25	11,36
710416	18	1800	6500	22/1200/32	25	11,36

## IŞILDAK

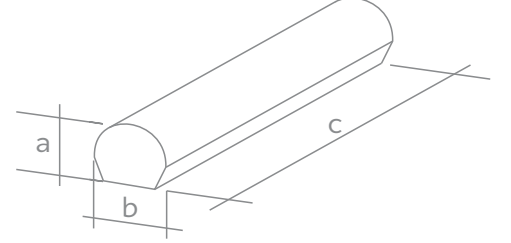

Sip. Kodu	Renk Sıcaklığı (K)	Ölçüler (a/b/c)	Fiyat (\$)
710458	6500	60/50/300	16,00
710457	4000	60/50/300	16,00

## LED SOKAK ARMATÜRLERİ

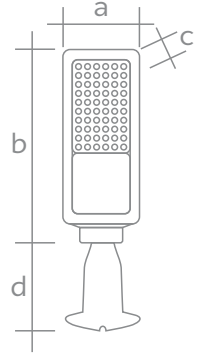

IP 65



Sip. Kodu	Güç (W)	Işık Akısı (lm)	Renk Sıcaklığı (K)	Ölçüler (a/b/c/d)	Koli Adedi	Fiyat (\$)
750900	50	5000	6500	131/300/73/160	1	51,63
750902	100	10000	6500	147/360/73/160	1	61,00
750904	150	15000	6500	167/420/73/160	1	83,00
750906	200	20000	6500	196/495/73/160	1	99,00

### Fotoselli

750901	50	5000	6500	131/300/73/160	1	52,66
750903	100	10000	6500	147/360/73/160	1	62,22
750905	150	15000	6500	167/420/73/160	1	101,00



## SOLAR KAZIKLI ÇİM ARMATÜRLERİ

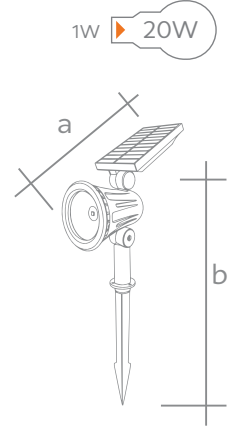

IP 65



Sip. Kodu	Güç (W)	Işık Akısı (lm)	Renk Sıcaklığı (K)	Ölçüler (a/b)	Koli Adedi	Fiyat (\$)
703201	1	100	3000	215/377	50	18,07
703202	1	100	6500	215/377	50	18,07
703203	1	100	Yeşil	215/377	50	18,07
703204	1	100	Amber	215/377	50	18,07

## SOLAR SET ÜSTÜ ARMATÜRLERİ

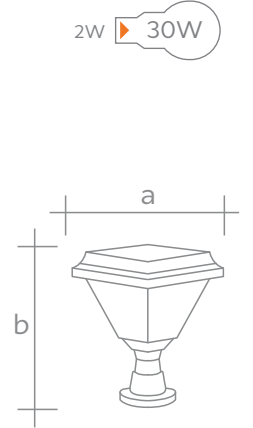

IP 65



Sip. Kodu	Güç (W)	Işık Akısı (lm)	Renk Sıcaklığı (K)	Ölçüler (a/b)	Koli Adedi	Fiyat (\$)
703101	2	300	3000	160/213	10	24,37
703102	2	300	6500	160/213	10	24,37
703103	2	300	RGB	160/213	10	24,37

## ŞARJLI - MANTAR MASA LAMBALARI

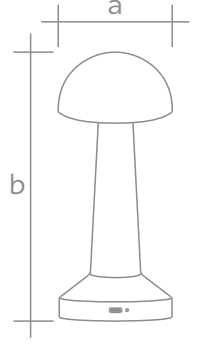

800 mAh  
18650 LI-ION PİL

3 SAAT

TYPE C

Dimmable

III

Sip. Kodu	Güç (W)	Işık Akısı (lm)	Renk Sıcaklığı (K) 3 Kademeli	Kasa Rengi	Ölçüler (a/b)	Koli Adedi	Fiyat (\$)
710470	2	110	6500 - 3200 - Amber	Altın	100/220	40	13,30
710471	2	110	6500 - 3200 - Amber	Bakır	100/220	40	13,30
750469	2	110	6500 - 3200 - Amber	Gümüş	100/220	40	13,30

## ŞARJLI - AKRİLİK MASA LAMBALARI

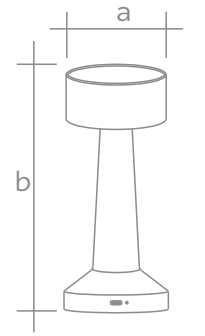

800 mAh  
18650 LI-ION PİL

3 SAAT

TYPE C

Dimmable

III

Sip. Kodu	Güç (W)	Işık Akısı (lm)	Renk Sıcaklığı (K) 3 Kademeli	Kasa Rengi	Ölçüler (a/b)	Koli Adedi	Fiyat (\$)
710472	2	110	6500 - 3200 - Amber	Altın	90/210	40	15,41
710473	2	110	6500 - 3200 - Amber	Bakır	90/210	40	15,41

## ŞARJLI - UFO MASA LAMBALARI

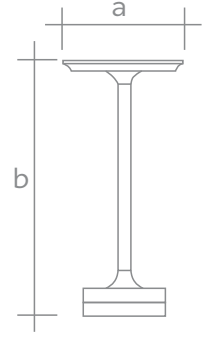

1200 mAh  
18650 LI-ION PİL

3 SAAT

TYPE C

Dimmable

III

Sip. Kodu	Güç (W)	Işık Akısı (lm)	Renk Sıcaklığı (K) 3 Kademeli	Kasa Rengi	Ölçüler (a/b)	Koli Adedi	Fiyat (\$)
710474	2	200	6500 - 4000 - 3000	Altın	125/280	20	24,84
710475	2	200	6500 - 4000 - 3000	Bakır	125/280	20	24,84

## SOLAR & ŞARJLI - KADEMELİ MASA LAMBALARI

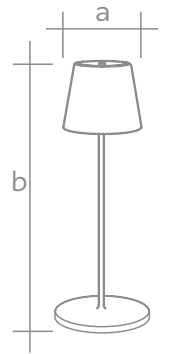

1800 mAh  
18650 LI-ION PİL

6 SAAT

TYPE C

Dimmable

III

Sip. Kodu	Güç (W)	Işık Akısı (lm)	Renk Sıcaklığı (K) 3 Kademeli	Kasa Rengi	Ölçüler (a/b)	Koli Adedi	Fiyat (\$)
710490	2	200	6500-4000-3000	Beyaz	116/360	40	29,40
710491	2	200	6500-4000-3000	Siyah	116/360	40	29,40

## ŞARJLI - KADEMELİ MASA LAMBALARI

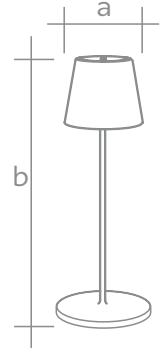

1200 mAh  
18650 LI-ION PİL

3 SAAT

TYPE C

Dimmable

III

Sip. Kodu	Güç (W)	Işık Akısı (lm)	Renk Sıcaklığı (K) 3 Kademeli	Kasa Rengi	Ölçüler (a/b)	Koli Adedi	Fiyat (\$)
710476	2	200	6500 - 4000 - 3000	Altın	116/360	20	20,20
710477	2	200	6500 - 4000 - 3000	Beyaz	116/360	40	20,20
710478	2	200	6500 - 4000 - 3000	Siyah	116/360	40	20,20



## FLÜT APLİKLER

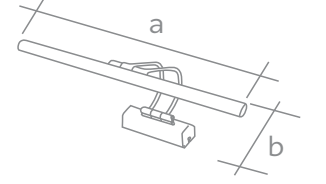

IP 20



25.000 Saat



Anında



≥ 80



Dimmable



IRUV



Hiç



□

Sip. Kodu	Güç (W)	Işık Akısı (lm)	Renk Sıcaklığı (K)	Kasa Rengi	Ölçüler (a/b)	Fiyat (₺)
720910	9	850	3000	Antrasit	430/230	26,88
720911	9	850	4000	Antrasit	430/230	26,88
720912	9	850	6500	Antrasit	430/230	26,88
720920	9	850	3000	Krom	430/230	34,65
720921	9	850	4000	Krom	430/230	34,65
720922	9	850	6500	Krom	430/230	34,65
720930	9	850	3000	Gold	430/230	34,65
720931	9	850	4000	Gold	430/230	34,65
720932	9	850	6500	Gold	430/230	34,65
720940	9	850	3000	Siyah	430/230	26,88
720941	9	850	4000	Siyah	430/230	26,88
720942	9	850	6500	Siyah	430/230	26,88



## DEKORATİF APLİKLER

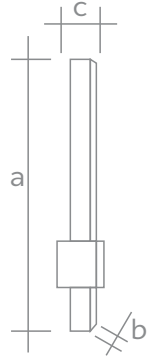

IP 20



25.000 Saat



Anında



≥ 80



Dimmable



IP 20



Hg



Sip. Kodu	Güç (W)	Işık Akısı (lm)	Renk Sıcaklığı (K)	Kasa Rengi	Ölçüler (a/b/c)	Fiyat (\$)
721110	11	1050	3000	Antrasit	570/45/60	29,61
721111	11	1050	4000	Antrasit	570/45/60	29,61
721112	11	1050	6500	Antrasit	570/45/60	29,61
721120	11	1050	3000	Krom	570/45/60	37,80
721121	11	1050	4000	Krom	570/45/60	37,80
721122	11	1050	6500	Krom	570/45/60	37,80
721130	11	1050	3000	Gold	570/45/60	37,80
721131	11	1050	4000	Gold	570/45/60	37,80
721132	11	1050	6500	Gold	570/45/60	37,80
721140	11	1050	3000	Siyah	570/45/60	29,61
721141	11	1050	4000	Siyah	570/45/60	29,61
721142	11	1050	6500	Siyah	570/45/60	29,61



## SIVA ÜSTÜ YUVARLAK SPOT KASALARI

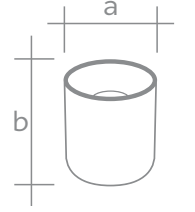

Sip. Kodu	Kasa Tipi	Kasa Rengi	Reflektör Rengi	Ölçüler (a/b)	Koli Adedi	Fiyat (\$)
720150	Yuvarlak	Siyah	Siyah	95/100	50	5,59
720151	Yuvarlak	Beyaz	Beyaz	95/100	50	5,59
720152	Yuvarlak	Siyah	Mat Bronz	95/100	50	5,89

## SIVA ÜSTÜ KARE SPOT KASALARI

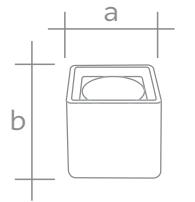

Sip. Kodu	Kasa Tipi	Kasa Rengi	Reflektör Rengi	Ölçüler (a/b)	Koli Adedi	Fiyat (\$)
720154	Kare	Siyah	Siyah	95/100	50	5,99
720155	Kare	Beyaz	Beyaz	95/100	50	5,99
720156	Kare	Siyah	Mat Bronz	95/100	50	6,38

## SIVA ÜSTÜ 2'Lİ KARE SPOT KASALARI



Sip. Kodu	Kasa Rengi	Reflektör Rengi	Ölçüler (a/b/c)	Koli Adedi	Fiyat (\$)
720158	Siyah	Siyah	90/100/180	30	11,97
720159	Beyaz	Beyaz	90/100/180	30	11,97
720160	Siyah	Mat Bronz	90/100/180	30	12,77



## SIVA ALTI YUVARLAK SPOT KASALARI



Sip. Kodu	Kasa Tipi	Kasa Rengi	Reflektör Rengi	Ölçüler (a/b)	Montaj Ölçüsü	Koli Adedi	Fiyat (\$)
720162	Yuvarlak	Siyah	Siyah	90/30	75 mm	100	2,23
720163	Yuvarlak	Siyah	Beyaz	90/30	75 mm	100	2,23
720164	Yuvarlak	Siyah	Mat Bronz	90/30	75 mm	100	2,63

## SIVA ALTI KARE SPOT KASALARI

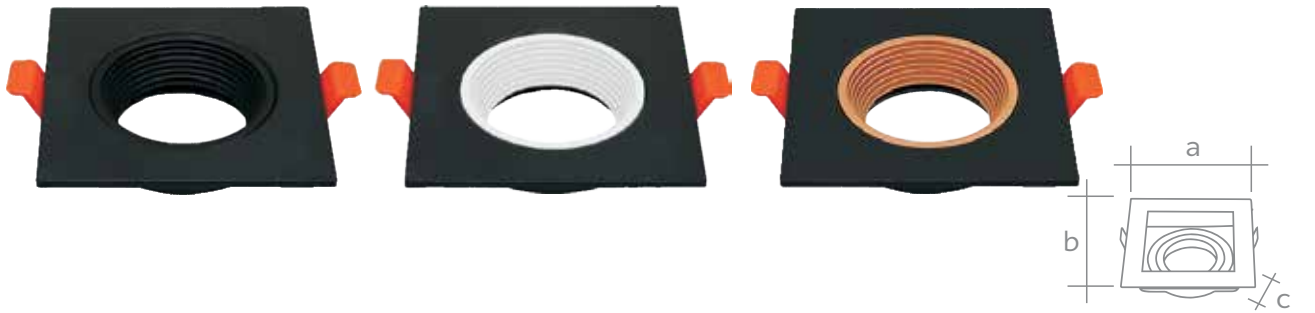

Sip. Kodu	Kasa Tipi	Kasa Rengi	Reflektör Rengi	Ölçüler (a/b/c)	Montaj Ölçüsü	Koli Adedi	Fiyat (\$)
720166	Kare	Siyah	Siyah	92/92/20	75 mm	100	2,32
720167	Kare	Siyah	Beyaz	92/92/20	75 mm	100	2,32
720168	Kare	Siyah	Mat Bronz	92/92/20	75 mm	100	2,73

## MONOFAZE RAY SPOTLAR



760401  
760501



760407  
760507



760413  
760513



760419  
760519



760426  
760526



760431  
760531



IP 20



50.000 Saat



Anında



≥ 80



Dimmable



IR UV



Hg



36°



Sip. Kodu	Kasa Rengi	Güç (W)	Işık Akısı (lm)	Renk Sıcaklığı (K)	Fiyat (\$)
760401	Siyah	30	3000	3000	43,25
760501	Beyaz	30	3000	3000	43,25
760407	Siyah	30	3000	3000	43,25
760507	Beyaz	30	3000	3000	43,25
760413	Siyah	30	3000	3000	47,12
760513	Beyaz	40	3000	3000	47,12
760419	Siyah	40	4000	3000	49,07
760519	Beyaz	40	4000	3000	49,07
760426	Siyah	40	4000	3000	49,04
760526	Beyaz	40	4000	3000	49,04
760431	Siyah	40	4000	3000	42,80
760531	Beyaz	40	4000	3000	42,80

## TRİFAZE RAY SOKETLERİ



Sip. Kodu	Kasa Rengi	Fiyat (\$)
730134	Siyah	5,00
730135	Beyaz	5,00

## MONOFAZE RAYLAR



Sip. Kodu	Uzunluk	Renk	Fiyat (\$)
730100	1	Siyah	8,06
730101	2	Siyah	16,12
730102	3	Siyah	24,19
730103	1	Beyaz	8,06
730104	2	Beyaz	16,12
730105	3	Beyaz	24,19

## MONOFAZE ARABAĞLANTI APARATLARI



Sip. Kodu	Renk	Fiyat (\$)
730108	Siyah	1,69
730109	Beyaz	1,69

## MONOFAZE L KÖŞE APARAT



Sip. Kodu	Renk	Fiyat (\$)
730114	Siyah	3,05
730115	Beyaz	3,05

## MONOFAZE T APARATLAR



Sip. Kodu	Renk	Fiyat (\$)
730106	Siyah	9,50
730107	Beyaz	9,50

## MONOFAZE SONLANDIRMA APARATLARI



Sip. Kodu	Renk	Fiyat (\$)
730112	Siyah	1,25
730113	Beyaz	1,25

## MONOFAZE ENERJİ GİRİŞ APARATLARI



Sip. Kodu	Renk	Fiyat (\$)
730110	Siyah	3,20
730111	Beyaz	3,20





## TORCH LED LAMBALAR

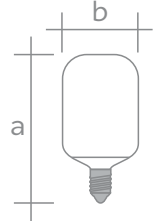

220 V



E 27



25.000 Saat



Anında



≥ 80



Dimmable



IRKUV



Hg

Sip. Kodu	Güç (W)	Işık Akısı (lm)	Renk Sıcaklığı (K)	Ölçüler (a/b)	Koli Adedi	Fiyat (\$)
500170	20	2100	6500	148,5/80	50	4,24
500173	30	3200	6500	174,5/100	40	5,73
500176	40	4300	6500	195,5/115	32	7,87
500179	50	5400	6500	218,2/120	24	10,69
500182	60	7250	6500	238,6/135	12	13,78

### E40 duylu

500179-E	50	5400	6500	218,2/120	24	13,78
500182-E	60	7250	6500	238,6/135	12	15,90



## KISA TORCH LED LAMBALAR

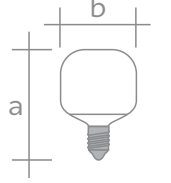

220 V



E 27



25.000 Saat



Anında



Ra  
≥ 80



Dimmable



IP54



Hg

Sip. Kodu	Güç (W)	Işık Akısı (lm)	Renk Sıcaklığı (K)	Ölçüler (a/b)	Koli Adedi	Fiyat (\$)
500185	20	2100	3000	123/80	60	4,24
500171	20	2100	6500	123/80	60	4,24
500187	30	3200	3000	140/100	45	5,73
500174	30	3200	6500	140/100	45	5,73
500189	40	4300	3000	155/115	36	7,87
500177	40	4300	6500	155/115	36	7,87
500191	50	5400	3000	173/125	32	10,69
500180	50	5400	6500	173/125	32	10,69

### Şeffaf

500172	20	2100	6500	2	123/80	60	4,24
500175	30	3200	6500	2	140/100	45	5,73
500178	40	4300	6500	2	155/115	36	7,87
500181	50	5400	6500	2	173/125	32	10,69

## KIVRIK BUJİ LED LAMBA

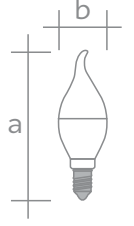

220 V



E 27



25.000 Saat



Anında



$\geq 80$



Dimmable



UV



Hg

Sip. Kodu	Güç (W)	Işık Akısı (lm)	Renk Sıcaklığı (K)	Ölçüler (a/b)	Koli Adedi	Fiyat (\$)
500227	5,5	420	6500	133/37	100	1,86

## P45 TOP LED LAMBA

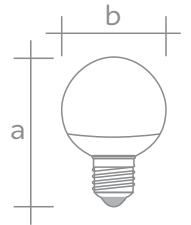

220 V



E 14



25.000 Saat



Anında



$\geq 80$



Dimmable



UV



Hg

Sip. Kodu	Güç (W)	Işık Akısı (lm)	Renk Sıcaklığı (K)	Ölçüler (a/b)	Koli Adedi	Fiyat (\$)
500262	4	280	6500	78/45	100	1,73

## GU10 MR 16 LED LAMBALAR

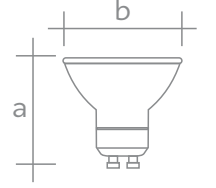

Sip. Kodu	Güç (W)	Işık Akısı (lm)	Renk Sıcaklığı (K)	Ölçüler (a/b)	Koli Adedi	Fiyat (\$)
500303	6	510	3000	50/57	100	0,78
500304	6	510	4000	50/57	100	0,78
500305	6	510	6500	50/57	100	0,78

## LENSLİ GU10 MR 16 LED LAMBALAR

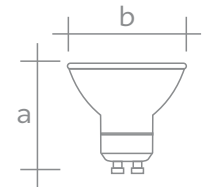

Sip. Kodu	Güç (W)	Işık Akısı (lm)	Renk Sıcaklığı (K)	Ölçüler (a/b)	Koli Adedi	Fiyat (\$)
500317	7	-	Yeşil	50/58	100	1,75
500403	7	-	Kırmızı	50/58	100	1,75

## GU5.3 MR 16 LED LAMBA

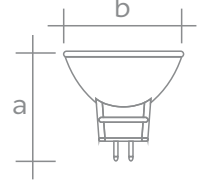

Sip. Kodu	Güç (W)	Işık Akısı (lm)	Renk Sıcaklığı (K)	Ölçüler (a/b)	Koli Adedi	Fiyat (\$)
500312	4,5	220	6500	52/50	100	2,78

## R50 SPOT LED LAMBALAR

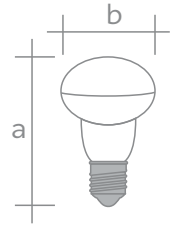

Sip. Kodu	Güç (W)	Işık Akısı (lm)	Renk Sıcaklığı (K)	Ölçüler (a/b)	Koli Adedi	Fiyat (\$)
500355	6	400	3000	86/50	100	2,78
500357	6	420	6500	86/50	100	2,78

## PAR 20 SPOT LED LAMBALAR

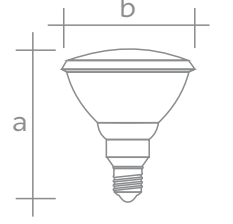

220 V



E 27



25.000 Saat



Anında



≥ 80



Dimmable



IR/UV



Hg



40°

Sip. Kodu	Güç (W)	Işık Akısı (lm)	Renk Sıcaklığı (K)	Ölçüler (a/b)	Koli Adedi	Fiyat (₺)
500370	7	508	3000	85/65	50	7,20
500372	7	508	6000	85/65	50	7,20

## PAR 30 SPOT LED LAMBA

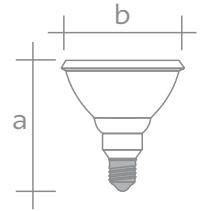

220 V



E 27



25.000 Saat



Anında



≥ 80



Dimmable



IR/UV



Hg



38°

Sip. Kodu	Güç (W)	Işık Akısı (lm)	Renk Sıcaklığı (K)	Ölçüler (a/b)	Koli Adedi	Fiyat (₺)
500379	12	870	6500	96/96	50	8,90

## UFO LED LAMBALAR

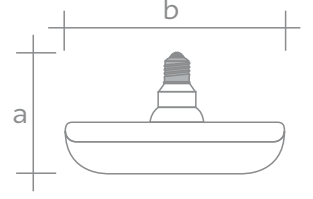

Sip. Kodu	Güç (W)	Işık Akısı (lm)	Renk Sıcaklığı (K)	Ölçüler (a/b)	Koli Adedi	Fiyat (\$)
500268	34	3400	6500	90/215	24	9,45
500270	34	3400	3000	90/215	24	9,45

## SEKİZGEN LED LAMBALAR

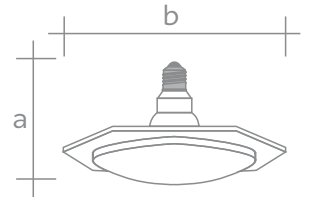

Sip. Kodu	Güç (W)	Işık Akısı (lm)	Renk Sıcaklığı (K)	Ölçüler (a/b)	Koli Adedi	Fiyat (\$)
500267	32	3100	6500	110/250	24	8,60
500269	32	3100	3000	110/250	24	8,60

## T8 LED TÜP LAMBALAR

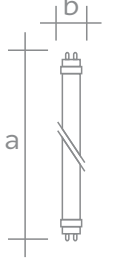

Sip. Kodu	Güç (W)	Işık Akısı (lm)	Renk Sıcaklığı (K)	Ölçüler (a/b)	Koli Adedi	Fiyat (\$)
500830	9	900	3000	600/28	25	4,90
500831	9	900	4000	600/28	25	4,90
500832	9	900	6500	600/28	25	4,90
500833	18	1800	3000	1200/28	25	6,45
500834	18	1800	4000	1200/28	25	6,45
500835	18	1800	6500	1200/28	25	6,45
500820	22	2265	6500	1500/28	25	8,00

## G9 KAPSÜL LED LAMBA

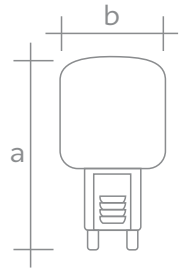

Sip. Kodu	Güç (W)	Işık Akısı (lm)	Renk Sıcaklığı (K)	Ölçüler (a/b)	Koli Adedi	Fiyat (\$)
500342	2	102	6500	42/24	100	2,00

## A60 FİLAMANLI LED LAMBA

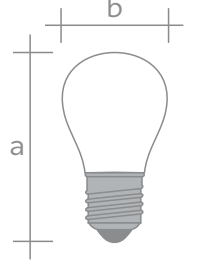

Sip. Kodu	Güç (W)	Işık Akısı (lm)	Renk Sıcaklığı (K)	Ölçüler (a/b)	Koli Adedi	Fiyat (\$)
500523	6	600	2200	106/60	50	4,51

## TOP FİLAMANLI LED LAMBA

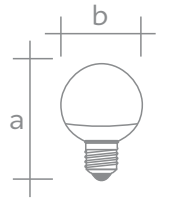

Sip. Kodu	Güç (W)	Işık Akısı (lm)	Renk Sıcaklığı (K)	Ölçüler (a/b)	Koli Adedi	Fiyat (\$)
500565	4	380	2200	74/45	100	3,15

## T25 FİLAMANLI LED LAMBALAR

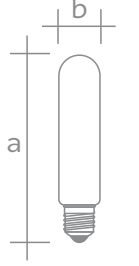

Sip. Kodu	Güç (W)	Işık Akısı (lm)	Renk Sıcaklığı (K)	Ölçüler (a/b)	Koli Adedi	Fiyat (\$)
500584	2	200	2700	85/25	50	3,20
500587	4	400	2700	125/25	50	3,92

## BUJİ FİLAMANLI LED LAMBA

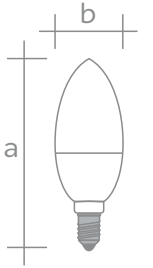

Sip. Kodu	Güç (W)	Işık Akısı (lm)	Renk Sıcaklığı (K)	Ölçüler (a/b)	Koli Adedi	Fiyat (\$)
500612	4	470	6500	100/35	50	2,70

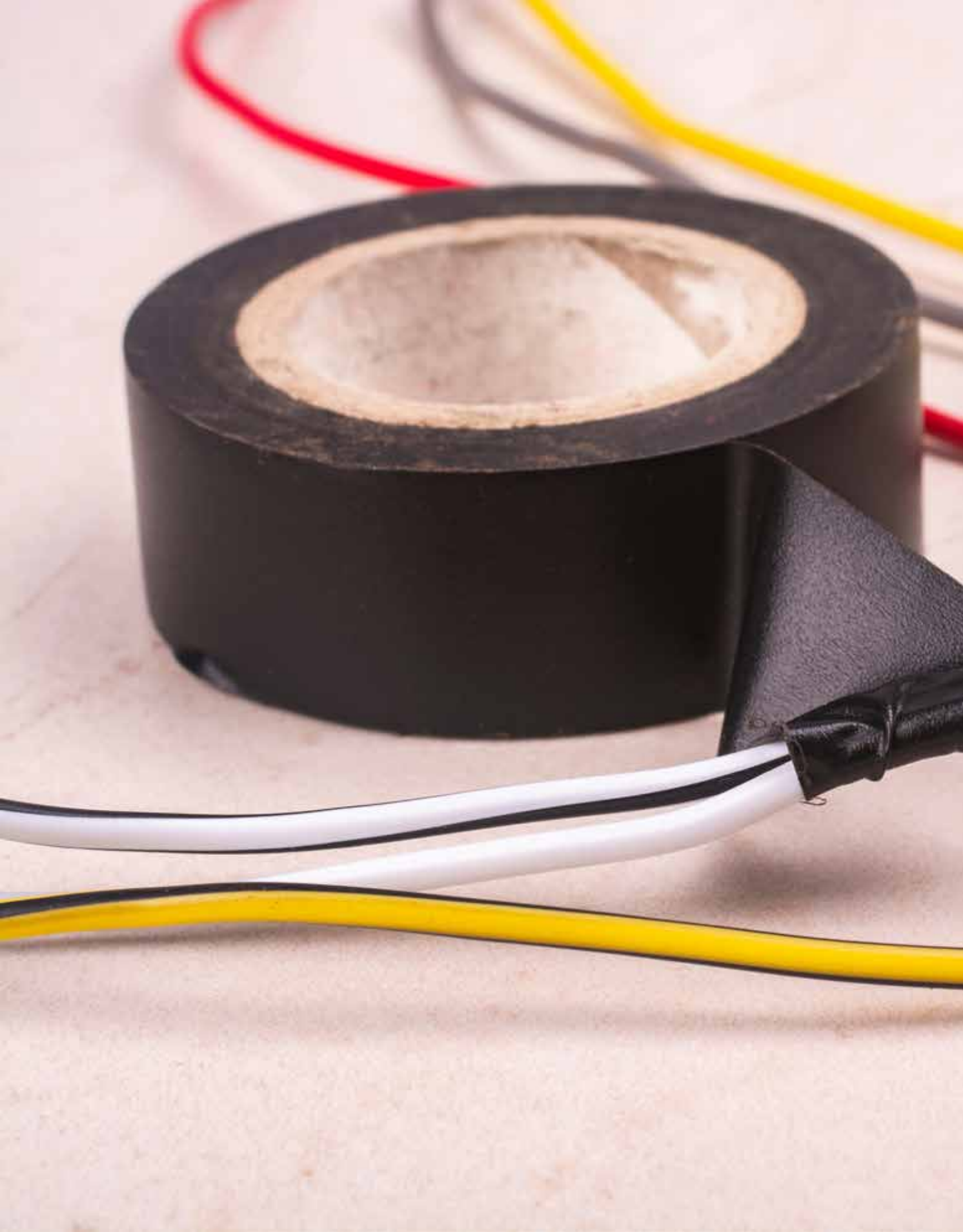

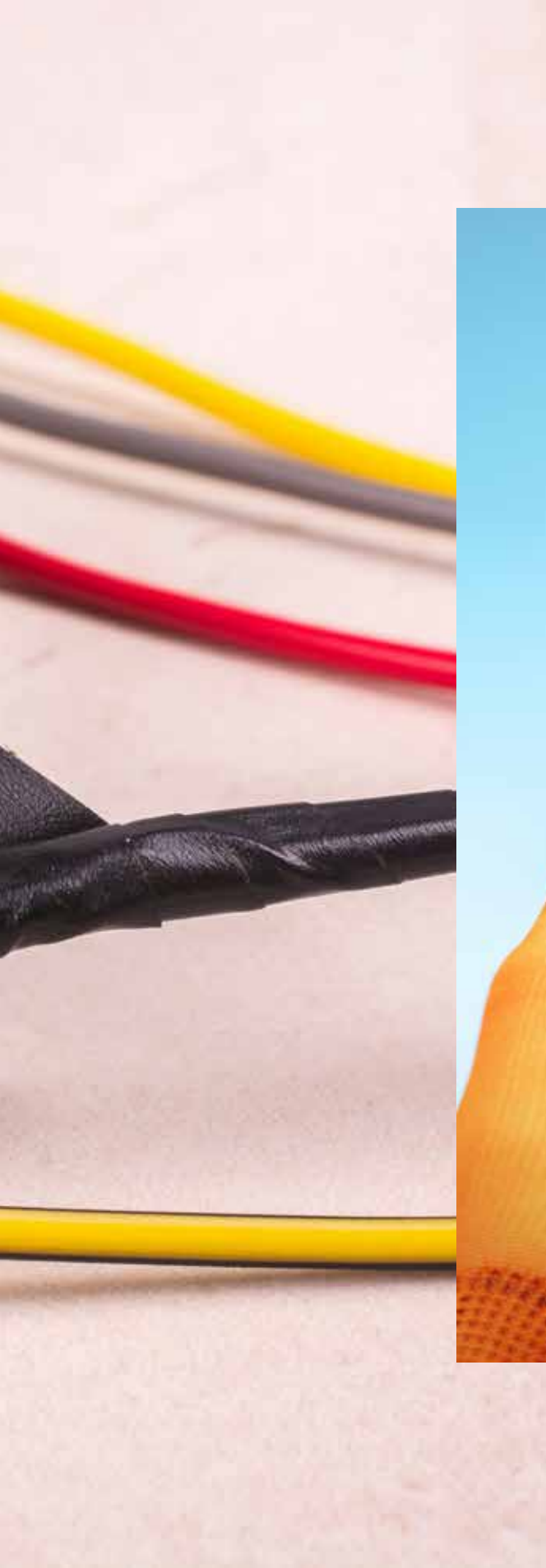

## PVC ELEKTRİK İZOLASYON BANTLARI



Sip. Kodu	Renk	Genişlik (mm)	Rulo Uzunluğu (M)	Koli Miktarı (Rulo)	Fiyat (\$)
800100	Siyah	19	9,1	500	0,54
800101	Beyaz	19	9,1	500	0,54
800102	Kırmızı	19	9,1	500	0,54
800103	Mavi	19	9,1	500	0,54
800104	Yeşil	19	9,1	500	0,54
800105	Sarı	19	9,1	500	0,54
800106	Gri	19	9,1	500	0,54
800107	Sarı/Yeşil	19	9,1	500	0,60
800108	Kahverengi	19	9,1	500	0,54
<b>Geniş</b>					
800110	Siyah	50	9,1	500	2,94

## KENDİNDEN ERİYEN BANTLAR



Sip. Kodu	Renk	Genişlik (mm)	Rulo Uzunluğu (M)	Koli Miktarı (Rulo)	Fiyat (\$)
800200	Siyah	19	8	60	2,36
800210	Siyah	50	8	24	6,20

## PVC DEKORATİF BANTLAR



Sip. Kodu	Renk	Sarım	Genişlik (mm)	Rulo Uzunluğu (M)	Koli Miktarı (Rulo)	Fiyat (\$)
800300	Beyaz	Dar	50	18	100	1,80
800301	Beyaz	Geniş	50	18	100	1,80





## 60 LEDLİ İÇ MEKAN ŞERİT LEDLER



IP 22



Sip. Kodu	Güç (W)	Işık Akısı (lm)	Renk Sıcaklığı (K)	Koli Adedi	Fiyat (\$)
<b>3030 Çipli</b>					
202010	9,6	800	3000	250	0,67
202011	9,6	800	4000	250	0,67
202012	9,6	800	6500	250	0,67
202013	9,6	-	Kırmızı	250	0,67
202014	9,6	-	Yeşil	250	0,67
202015	9,6	-	Amber	250	0,70
<b>5630 Çipli</b>					
101102	14,4	500	6500	250	1,06

## 120 LEDLİ İÇ MEKAN ŞERİT LEDLER



12 V

IP 22



2835

120 Adet  
1 metre



≥ 80



Sip. Kodu	Güç (W)	Işık Akısı (lm)	Renk Sıcaklığı (K)	Koli Adedi	Fiyat (\$)
202020	9,6	800	3000	250	1,13
202021	9,6	800	4000	250	1,13
202022	9,6	800	6500	250	1,13
202023	9,6	-	Kırmızı	250	1,13
202024	9,6	-	Yeşil	250	1,13
202025	9,6	-	Amber	250	1,19

## İÇ MEKAN ŞERİT LEDLER



IP 22



Sip. Kodu	Güç (W)	Işık Akısı (lm)	Renk Sıcaklığı (K)	Koli Adedi	Fiyat (\$)
<b>2835 Çipli</b>					
201101	4,8	400	6500	250	0,56
201103	4,8	-	Kırmızı	250	0,56
201105	4,8	-	Yeşil	250	0,56
201106	4,8	-	Amber	250	0,56
<b>4040 Çipli</b>					
200624	10	-	Mavi	200	0,70
<b>4040 Çipli</b>					
200614	14,4	-	Mavi	250	0,99

## DIŞ MEKAN ŞERİT LEDLER



IP 65



Sip. Kodu	Güç (W)	Işık Akısı (lm)	Renk Sıcaklığı (K)	Koli Adedi	Fiyat (\$)
<b>5050 Çipli</b>					
206317	14,4	-	RGB	250	2,63
206411	10	-	6500	250	1,17
<b>2835 Çipli</b>					
206303	4,8	-	Kırmızı	200	0,53
206304	4,8	-	Mavi	200	0,53

## 12V / 24V NEON ŞERİT LEDLER

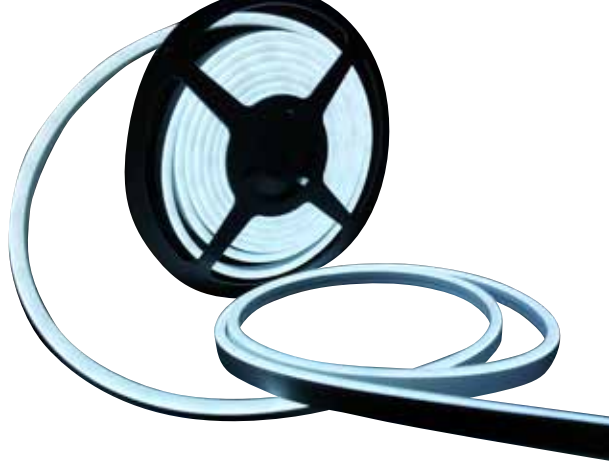

IP 67



2835



120 Adet  
1 metre



≥ 80



Sip. Kodu	Güç (W)	Renk Sıcaklığı (K)	Rulo	Ölçüler (mm)	Fiyat (\$)
<b>12V Neon</b>					
206701	9	6500	5 Metre	5/11	4,60
206702	9	3000	5 Metre	5/11	4,60
206710	9	4000	5 Metre	5/11	4,60
206711	9	6500	50 Metre	5/11	4,60
206712	9	3000	50 Metre	5/11	4,60
206720	9	4000	50 Metre	5/11	4,60
206703	9	Kırmızı	5 Metre	5/11	4,60
206704	9	Mavi	5 Metre	5/11	4,60
206705	9	Yeşil	5 Metre	5/11	4,60
206706	9	Amber	5 Metre	5/11	4,60
206707	9	Pembe	5 Metre	5/11	4,60
206709	9	Buz Mavisi	5 Metre	5/11	4,60
206714	9	Mavi	50 Metre	5/11	4,60
206716	9	Amber	50 Metre	5/11	4,60
<b>24V Neon</b>					
206602	9	3000	5 Metre	5/11	4,90
206606	9	Amber	5 Metre	5/11	4,90

## ESNEK FLORESANLAR



IP 68



Sip. Kodu	Güç (W)	Renk Sıcaklığı (K)	Rulo	Ölçüler (mm)	Fiyat (\$)
206901	14,4	6500	10 Metre	12/13	26,40
206902	14,4	3000	10 Metre	12/13	26,40
206903	14,4	Kırmızı	10 Metre	12/13	26,40
206904	14,4	Mavi	10 Metre	12/13	26,40
206905	14,4	Yeşil	10 Metre	12/13	26,40
206906	14,4	Amber	10 Metre	12/13	28,00

## 24V FLEX NEON ŞERİT LEDLER



IP 68



Sip. Kodu	Güç (W)	Renk Sıcaklığı (K)	Rulo	Ölçüler (mm)	Fiyat (\$)
206501	12	6500	10 Metre	13/13	11,60
206502	12	3000	10 Metre	13/13	11,60
206510	12	4000	10 Metre	13/13	11,60
206506	12	Amber	10 Metre	13/13	11,60





## OVAL INFRARED LAMBALAR

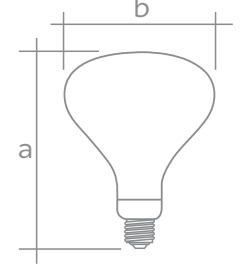

Sip. Kodu	Güç (W)	Gerilim (V)	Cam Rengi	Duy	Ölçüler (a/b)	Koli Adedi	Fiyat (\$)
41000	100	230	Kırmızı	E27	128/95	50	12,51
41011	175	230	Kırmızı	E27	134/122	12	14,84
41015	150	230	Kırmızı	E27	183/125	24	11,30
41016	150	230	Şeffaf	E27	183/125	24	10,01
41020	250	230	Kırmızı	E27	183/125	24	11,30
41021	250	230	Şeffaf	E27	183/125	24	10,01
41026	375	230	Şeffaf	E27	183/125	24	17,49

## SERAMİK INFRARED LAMBA

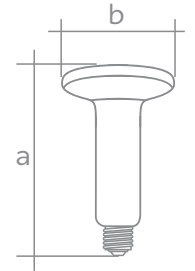

Sip. Kodu	Güç (W)	Gerilim (V)	Gövde Rengi	Duy	Ölçüler (a/b)	Koli Adedi	Fiyat (\$)
41030	100	220	Siyah	E27	110/75	60	12,51

## METAL UÇLU ÇUBUK INFRARED LAMBALAR

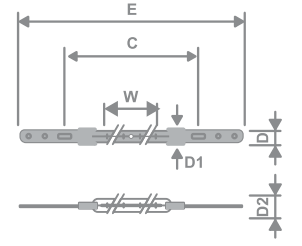

Sip. Kodu	Güç (W)	Gerilim (V)	Ölçüler (mm)						Reflektör	Uç	Fiyat (\$)
			C	W	E	D	D1	D2			
40900	1000	235	365	285	470	12,3	10	14,6	Yok	X/98	-
40901	1000	400	365	290	470	12,3	10	14,6	Beyaz	X/98	-
40912	2000	400	550	426	610	12,3	10	14,6	Beyaz	X/98	-
40914	3000	400	769	721	902	12,3	10	14,6	Beyaz	X/98	-
40917	2500	400	820	635	820	12,3	10	14,6	Beyaz	X/98	-
40931	1600	380	820	635	820	12,3	10	14,6	Yok	X/98	-
40946	2000	400	705	520	705	12,3	10	14,6	Beyaz	X	-

## SK15 SERAMİK UÇLU ÇUBUK INFRARED LAMBALAR

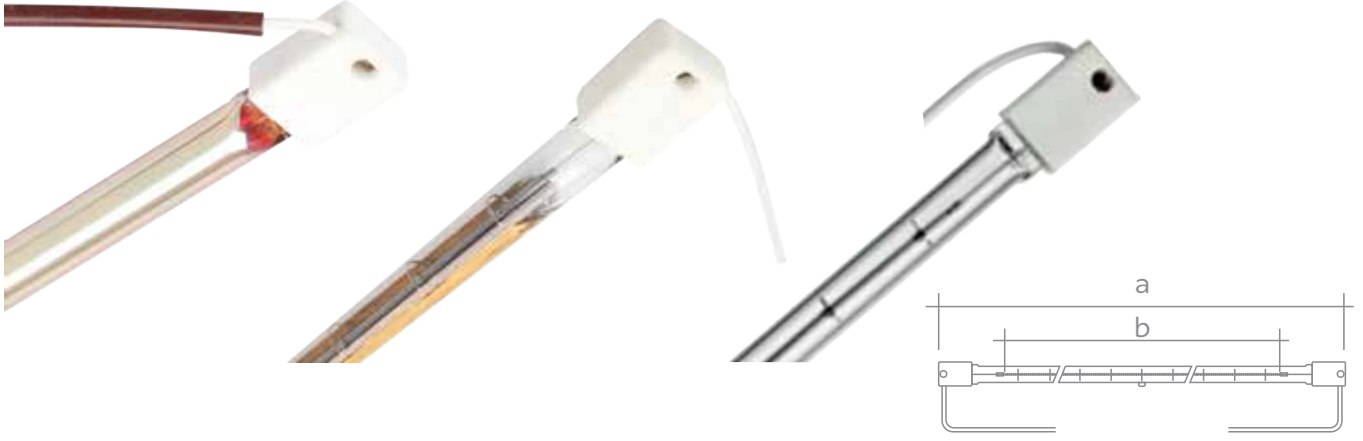

Sip. Kodu	Güç (W)	Gerilim (V)	Ölçüler (mm)		Kablo (cm)	Reflektör	Duy	Uç	Fiyat (\$)
			A	B					
40800	500	235	120	40	30	Beyaz	SK15	Düz	-
40801	600	235	150	70	30	Altın	SK15	Düz	-
40802	950	235	219	139	50	Yakut Kaplama	SK15	Düz	-
40803	1200	235	224	144	40	Beyaz	SK15	Düz	-
40804	500	235	224	144	40	Beyaz	SK15	Düz	-
40805	1000	235	277	197	40	Beyaz	SK15	Düz	-
40806	2000	235	277	197	40	Beyaz	SK15	Düz	-
40807	2200	235	355	275	80	Altın Kaplama	SK15	Düz	-
40808	1000	235	355	275	80	Altın Kaplama	SK15	Düz	-
40809	1500	235	355	275	80	Altın Kaplama	SK15	Düz	-
40810	2000	235	355	275	80	Altın Kaplama	SK15	Düz	-
40811	2000	235	355	275	60	Beyaz	SK15	Düz	-
40812	1000	235	355	275	60	Beyaz	SK15	Düz	-
40813	1000	380	355	275	60	Beyaz	SK15	Düz	-
40814	2000	380	355	275	60	Beyaz	SK15	Düz	-
40815	2500	380	355	275	60	Beyaz	SK15	Düz	-
40816	3000	380	355	275	60	Beyaz	SK15	Düz	-
40817	2500	380	378	298	70	Beyaz	SK15	Düz	-
40818	3000	380	378	298	70	Beyaz	SK15	Düz	-
40819	2500	235	430	350	70	Beyaz	SK15	Düz	-
40820	3000	380	430	350	70	Beyaz	SK15	Düz	-
40821	1500	235	440	360	70	Beyaz	SK15	Düz	-
40822	1000	380	445	365	70	Beyaz	SK15	Düz	-
40823	2000	235	495	415	70	Beyaz	SK15	Düz	-
40824	2000	235	495	415	70	Yok	SK15	Düz	-
40825	3000	400	520	440	80	Altın Kaplama	SK15	Düz	-
40826	1000	235	655	575	80	Beyaz	SK15	Düz	-
40827	2500	235	750	670	80	Yok	SK15	Düz	-
40828	3000	235	787	707	80	Beyaz	SK15	Düz	-
40829	3000	380	787	707	80	Beyaz	SK15	Düz	-
40830	2000	235	950	870	80	Beyaz	SK15	Düz	-
40831	2000	235	980	900	90	Beyaz	SK15	Düz	-
40832	2500	380	980	900	90	Beyaz	SK15	Düz	-
40833	2000	235	920	840	90	Beyaz	SK15	Düz	-
40834	2000	235	1100	1020	90	Beyaz	SK15	Düz	-
40835	2000	380	920	840	90	Beyaz	SK15	Düz	-
40910	2000	235	495	415	100	Yok	SK15	Çatal	-
40947	2000	235	520	440	30	Beyaz	SK15	Çatal	-

## R7S SERAMİK UÇLU ÇUBUK INFRARED LAMBALAR

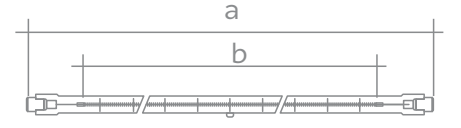

Sip. Kodu	Güç (W)	Gerilim (V)	Ölçüler (mm)		Kablo (cm)	Reflektör	Duy	Uç	Fiyat (\$)
			A	B					
40836	2500	380	605	525	70	Beyaz	R7S	Düz	-
40837	3000	380	605	525	70	Beyaz	R7S	Düz	-
40838	950	235	219	139	70	Altın Kaplama	R7S	Düz	-
40839	1800	235	474	394	Kablosuz	Beyaz	R7S	Düz	-
40840	1600	235	450	370	Kablosuz	Beyaz	R7S	Düz	-
40841	1000	235	277	197	Kablosuz	Beyaz	R7S	Düz	-
40842	750	235	224	144	Kablosuz	Beyaz	R7S	Düz	-

## LD04 SERAMİK UÇLU ÇUBUK INFRARED LAMBALAR (İKİZ TÜP)

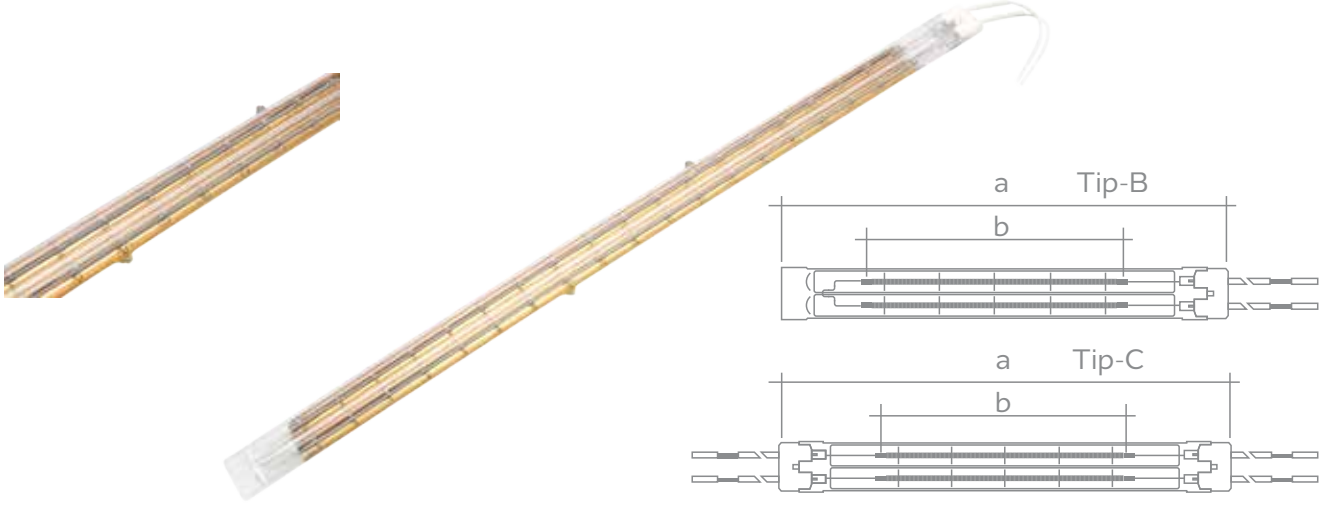

Sip. Kodu	Güç (W)	Gerilim (V)	Ölçüler (mm)		Kablo (cm)	Reflektör	Duy	Uç	Fiyat (\$)
			A	B					
40843	1000	235	150	50	30	Altın	LD04 - Tip B	Düz	-
40844	1000	380	150	50	30	Altın	LD04 - Tip B	Düz	-
40845	1500	235	200	100	30	Altın	LD04 - Tip B	Düz	-
40846	6000	380	1150	1050	120	Altın	LD04 - Tip C	Düz	-

## T8 BL LED LAMBALAR



365+398 nm  
Tepe Dalga  
Boyu

Sip. Kodu	Güç (W)	İrradyans ★ (μW/cm <sup>2</sup> )	Ölçüler (a/b)	Koli Adedi	Fiyat (\$)
30500	6	15,61	437,4/26	25	-
30501	8	23,48	589,8/26	25	-

★ İrradyans değerleri 1 metrede ölçülen değerlerdir

## T5 BL LAMBALAR



365 nm  
Tepe Dalga  
Boyu

Sip. Kodu	Güç (W)	İrradyans ★ (μW/cm <sup>2</sup> )	Ölçüler (a/b)	Koli Adedi	Fiyat (\$)
30900	4	3,2	150/16	20	2,23
30901	6	6	226/16	20	2,23
30902	8	9	302/16	20	2,36

★ İrradyans değerleri 1 metrede ölçülen değerlerdir

## T8 BL LAMBALAR



G13



5.000 Saat

365 nm  
Tepe Dalga  
Boy

Sip. Kodu	Güç (W)	İrradyans ( $\mu\text{W}/\text{cm}^2$ )	Ölçüler (a/b)	Koli Adedi	Fiyat (\$)
30903	10	18	331/28	25	2,74
30904	15	23	451/28	25	3,65
30905	18	30	604/28	25	4,24
30906	20	36	604/28	25	5,23
30908	36	42	604/28	25	5,05
30909	36	58	1213/28	25	6,39

★ İrradyans değerleri 1 metrede ölçülen değerlerdir

## T5 BLACKLIGHT BLUE (BLB) LAMBALAR



G5



4.000 Saat

350-390 nm  
Tepe Dalga  
Boy

Sip. Kodu	Güç (W)	İrradyans ★ ( $\mu\text{W}/\text{cm}^2$ )	Ölçüler (a/b)	Koli Adedi	Fiyat (\$)
30950	4	2,5	150/16	20	2,46
30951	6	5	226/16	20	2,55
30952	8	8	302/16	20	2,97

★ İrradyans değerleri 1 metrede ölçülen değerlerdir

## T8 BLACKLIGHT BLUE (BLB) LAMBALAR



G13



6.000 Saat

350 - 390 nm  
Tepe Dalga  
Boyu

Sip. Kodu	Güç (W)	İrradyans ★ (μW/cm <sup>2</sup> )	Ölçüler (a/b)	Koli Adedi	Fiyat (\$)
30954	15	20,6	431/28	25	7,07
30955	18	27	604/28	25	8,55
30957	30	32	604/28	25	10,77
30958	36	37,8	1213/28	25	13,24

★ Irradyans değerleri 1 metrede ölçülen değerlerdir

## ELEKTRONİK BALASTLAR



220 V

IP 20



Sip. Kodu	Güç (W)	Akım (A)	Fiyat (\$)
50500	2X18	0,16	12,40
50501	1X36	0,16	11,50

## T5 UV-C LAMBALAR



G5



5.000 Saat

254 nm  
Tepe Dalga  
Boyu



OZON  
ÜRETMEZ

Sip. Kodu	Güç (W)	İrradyans ★ (µW/cm²)	Ölçüler (a/b)	Koli Adedi	Fiyat (\$)
30806	6	11	150/16	25	5,46
30807	8	15	226/16	25	6,52
30814	11	22	212/16	25	8,25

★ İrradyans değerleri 1 metrede ölçülen değerlerdir

## T8 UV-C LAMBALAR



G13



5.000 Saat

254 nm  
Tepe Dalga  
Boyu



OZON  
ÜRETMEZ

Sip. Kodu	Güç (W)	İrradyans ★ (µW/cm²)	Ölçüler (a/b)	Koli Adedi	Fiyat (\$)
30808	15	48	451/28	25	7,99
30809	30	85	901/28	25	14,11
30810	36	105	1213/28	25	21,32
30811	55	135	909/28	25	18,50
30817	75	180	1199/28	25	27,37

★ İrradyans değerleri 1 metrede ölçülen değerlerdir

## PLL UV-C LAMBALAR



2G11



10.000 Saat

254 nm  
Tepe Dalga  
Boyu



OZON  
ÜRETMEZ

Sip. Kodu	Güç (W)	İrradyans ★ (μW/cm <sup>2</sup> )	Ölçüler (a/b)	Koli Adedi	Fiyat (\$)
30812	36	105	415/18	25	21,29
30813	55	142	535/17	25	23,96

★ İrradyans değerleri 1 metrede ölçülen değerlerdir

## T5 4P UV-C LAMBALAR



G10q



10.000 Saat

254 nm  
Tepe Dalga  
Boyu



OZON  
ÜRETMEZ

Sip. Kodu	Güç (W)	İrradyans (μW/cm <sup>2</sup> )	Ölçüler (a/b)	Koli Adedi	Fiyat (\$)
30820	14	40	287/16	25	25,08
30823	17	55	357/16	25	33,06
30826	21	72	436/16	25	43,32
30829	41	150	843/16	25	47,88
30832	65	189	843/16	25	60,00

## CAM KILIFLAR



Sip. Kodu	Ürün	Fiyat (\$)
30920	30820 için 320mm Kuvars Kılıf	7,00
30923	30823 için 390mm Kuvars Kılıf	7,50
30926	30826 için 470mm Kuvars Kılıf	8,00
30929	30829/30832 için 875mm Kuvars Kılıf	12,00

Sip. Kod	Fiyat (\$)	Sayfa No
760250	23,00	2
760251	23,00	2
760252	23,00	2
760260	32,30	2
760261	32,30	2
760262	32,30	2
760360	33,92	2
760361	33,92	2
760362	33,92	2
760270	43,50	2
760271	43,50	2
760272	43,50	2
760540	56,00	2
760541	56,00	2
760542	56,00	2
760290	75,00	3
760291	75,00	3
760292	75,00	3
760300	79,00	3
760301	79,00	3
760302	79,00	3
760660	60,60	3
760661	60,60	3
760662	60,60	3
760670	72,64	3
760671	72,64	3
760672	72,64	3
760760	100,00	3
760761	100,00	3
760762	100,00	3
760247	17,60	4
760248	17,60	4
760249	17,60	4
760263	25,00	4
760264	25,00	4
760265	25,00	4
760860	23,00	4
760861	23,00	4
760862	23,00	4
760310	24,00	5
760311	24,00	5
760312	24,00	5
760320	33,80	5
760321	33,80	5
760322	33,80	5
760460	35,60	5
760461	35,60	5
760462	35,60	5
760330	45,60	5
760331	45,60	5
760332	45,60	5
750822	59,60	6
750832	76,60	6
750842	96,00	6
750622	66,70	6
750632	100,00	6
750722	98,60	6
750732	134,00	6
750742	152,00	6

Sip. Kod	Fiyat (\$)	Sayfa No
750342	-	7
750342	-	7
750342	-	7
770052	270	7
770054	243,6	7
750400	11,50	8
750402	11,50	8
750403	12,00	8
750404	12,50	8
750405	26,00	8
750410	19,00	8
750412	19,00	8
750413	21,00	8
750414	21,50	8
750430	24,80	8
750432	24,80	8
750435	26,20	8
750450	38,50	8
750452	38,50	8
750460	70,00	8
750462	70,00	8
750470	85,20	8
750472	85,20	8
750474	89,46	8
750490	172,00	8
750492	172,00	8
750591	245,00	8
750592	245,00	8
750442	30,47	8
770110	73,96	10
770112	73,96	10
770113	78,26	10
770114	78,26	10
770115	78,26	10
770116	78,26	10
770140	100,15	10
770142	100,15	10
770143	105,60	10
770144	105,60	10
770145	105,60	10
770146	105,60	10
770170	140,21	10
770172	140,21	10
770173	154,32	10
770174	154,32	10
770175	154,32	10
770176	154,32	10
770230	209,55	10
770232	209,55	10
770233	227,49	10
770234	227,49	10
770235	227,49	10
770236	227,49	10

Sip. Kod	Fiyat (\$)	Sayfa No
780110	84,74	11
780112	84,74	11
780113	90,07	11
780114	90,07	11
780115	90,07	11
780116	90,07	11
780140	115,56	11
780142	115,56	11
780143	121,08	11
780144	121,08	11
780145	121,08	11
780146	121,08	11
770300	43,75	11
770301	69,25	11
770302	85,70	11
770304	127,50	11
702103	18,72	12
702203	18,72	12
702403	18,72	12
702101	17,68	12
702201	17,68	12
702401	17,68	12
702104	24,65	12
702204	24,65	12
702304	24,65	12
702102	21,50	12
702202	21,50	12
702402	21,50	12
702123	19,59	13
702223	19,59	13
702124	25,61	13
702224	25,61	13
702424	25,61	13
701107	23,70	13
701207	23,70	13
701307	26,28	13
701109	26,76	13
701209	26,76	13
701309	29,43	13
701106	29,43	14
702206	29,43	14
702108	27,14	14
702208	27,14	14
702308	31,34	14
702105	65,46	14
702205	65,46	14
702180	85,04	14
702181	100,33	14
702182	118,00	14
702280	85,04	14
702281	100,33	14
702282	118,00	14

Sip. Kod	Fiyat (\$)	Sayfa No
701101	18,16	15
701201	18,16	15
701302	23,51	15
701301	23,51	15
701402	21,50	15
701401	21,50	15
701601	13,76	15
760489	25,60	16
760490	25,60	16
760491	25,60	16
760497	32,44	16
760498	32,44	16
760499	32,44	16
760493	-	16
760494	-	16
760495	-	16
760253	8,80	16
760256	8,80	16
760471	32,00	17
760472	32,00	17
760473	32,00	17
760479	38,84	17
760480	38,84	17
760481	38,84	17
760475	-	17
760476	-	17
760477	-	17
710700	4,80	17
710760	13,40	17
710775	24,40	17
710710	5,28	17
710770	16,40	17
710765	1,90	17
702186	15,20	18
712186	20,34	18
702196	17,10	18
702191	13,80	19
702194	10,47	19
710233	8,80	20
710236	8,80	20
710243	16,54	20
710246	16,54	20
711223	9,85	20
711226	9,85	20
711243	13,38	20
711246	13,38	20

Sip. Kod	Fiyat (\$)	Sayfa No
710033	3,10	21
710034	3,10	21
710036	3,10	21
710063	4,00	21
710064	4,00	21
710066	4,00	21
710093	4,89	21
710094	4,89	21
710096	4,89	21
710123	5,76	21
710124	5,76	21
710126	5,76	21
710153	6,51	21
710154	6,51	21
710156	6,51	21
710183	7,17	21
710184	7,17	21
710186	7,17	21
710213	10,80	22
710214	10,80	22
710215	10,80	22
710220	15,54	22
710221	15,54	22
710222	15,54	22
710411	7,48	22
710412	7,48	22
710413	7,48	22
710414	11,36	22
710415	11,36	22
710416	11,36	22
710458	16,00	23
710457	16,00	23
750900	51,63	24
750902	61,00	24
750904	83,00	24
750906	99,00	24
750901	52,66	24
750903	62,22	24
750905	101,00	24
703201	18,07	25
703202	18,07	25
703203	18,07	25
703204	18,07	25
703101	24,37	25
703102	24,37	25
703103	24,37	25

Sip. Kod	Fiyat (\$)	Sayfa No
710470	13,30	26
710471	13,30	26
750469	13,30	26
710472	15,41	26
710473	15,41	26
710474	24,84	27
710475	24,84	27
710490	29,40	27
710491	29,40	27
710476	20,20	28
710477	20,20	28
710478	20,20	28
720910	26,88	29
720911	26,88	29
720912	26,88	29
720920	34,65	29
720921	34,65	29
720922	34,65	29
720930	34,65	29
720931	34,65	29
720932	34,65	29
720940	26,88	29
720941	26,88	29
720942	26,88	29
721110	29,61	30
721111	29,61	30
721112	29,61	30
721120	37,80	30
721121	37,80	30
721122	37,80	30
721130	37,80	30
721131	37,80	30
721132	37,80	30
721140	29,61	30
721141	29,61	30
721142	29,61	30
720150	5,59	31
720151	5,59	31
720152	5,89	31
720154	5,99	31
720155	5,99	31
720156	6,38	31
720158	11,97	32
720159	11,97	32
720160	12,77	32

Sip. Kod	Fiyat (\$)	Sayfa No
720162	2,23	33
720163	2,23	33
720164	2,63	33
720166	2,32	33
720167	2,32	33
720168	2,73	33
760401	43,25	34
760501	43,25	34
760407	43,25	34
760507	43,25	34
760413	47,12	34
760513	47,12	34
760419	49,07	34
760519	49,07	34
760426	49,04	34
760526	49,04	34
760431	42,80	34
760531	42,80	34
730134	5,00	34
730135	5,00	34
730100	8,06	35
730101	16,12	35
730102	24,19	35
730103	8,06	35
730104	16,12	35
730105	24,19	35
730108	1,69	35
730109	1,69	35
730114	3,05	35
730115	3,05	35
730106	9,50	35
730107	9,50	35
730112	1,25	35
730113	1,25	35
730110	3,20	35
730111	3,20	35
500170	4,00	38
500173	5,40	38
500176	7,42	38
500179	10,08	38
500182	13,00	38
500179-E	13,00	38
500182-E	15,00	38

Sip. Kod	Fiyat (\$)	Sayfa No
500185	4,00	39
500171	4,00	39
500187	5,40	39
500174	5,40	39
500189	7,42	39
500177	7,42	39
500191	10,08	39
500180	10,08	39
500172	4,00	39
500175	5,40	39
500178	7,42	39
500181	10,08	39
500227	1,86	40
500262	1,73	40
500303	0,78	41
500304	0,78	41
500305	0,78	41
500317	1,75	41
500403	1,75	41
500312	2,78	42
500355	2,78	42
500357	2,78	42
500370	7,20	43
500372	7,20	43
500379	8,90	43
500268	9,45	44
500270	9,45	44
500267	8,60	44
500269	8,60	44
500830	2,00	45
500831	4,90	45
500832	4,90	45
500833	4,90	45
500834	6,45	45
500835	6,45	45
500820	6,45	45
500342	8,00	45
500523	4,51	46
500565	3,15	46
500584	3,20	47
500587	3,92	47
500612	2,70	47

Sip. Kod	Fiyat (\$)	Sayfa No
800100	0,54	50
800101	0,54	50
800102	0,54	50
800103	0,54	50
800104	0,54	50
800105	0,54	50
800106	0,54	50
800107	0,60	50
800108	0,54	50
800110	2,94	50
800200	2,36	51
800210	6,20	51
800300	1,80	51
800301	1,80	51
202010	0,67	54
202011	0,67	54
202012	0,67	54
202013	0,67	54
202014	0,67	54
202015	0,70	54
101102	1,06	54
202020	1,13	55
202021	1,13	55
202022	1,13	55
202023	1,13	55
202024	1,13	55
202025	1,19	55
201101	0,56	56
201103	0,56	56
201105	0,56	56
201106	0,56	56
200624	0,70	56
200614	0,99	56
206317	2,63	57
206411	1,17	57
206303	0,53	57
206304	0,53	57

Sip. Kod	Fiyat (\$)	Sayfa No
206701	4,60	58
206702	4,60	58
206710	4,60	58
206711	4,60	58
206712	4,60	58
206720	4,60	58
206703	4,60	58
206704	4,60	58
206705	4,60	58
206706	4,60	58
206707	4,60	58
206709	4,60	58
206714	4,60	58
206716	4,60	58
206602	4,90	58
206606	4,90	58
206901	26,40	59
206902	26,40	59
206903	26,40	59
206904	26,40	59
206905	26,40	59
206906	28,00	59
206501	11,60	59
206502	11,60	59
206510	11,60	59
206506	11,60	59
41000	12,51	62
41011	14,84	62
41015	11,30	62
41016	10,01	62
41020	11,30	62
41021	10,01	62
41026	17,49	62
41030	12,51	62
40900	-	63
40901	-	63
40912	-	63
40914	-	63
40917	-	63
40931	-	63
40946	-	63

Sip. Kod	Fiyat (\$)	Sayfa No
40800	-	64
40801	-	64
40802	-	64
40803	-	64
40804	-	64
40805	-	64
40806	-	64
40807	-	64
40808	-	64
40809	-	64
40810	-	64
40811	-	64
40812	-	64
40813	-	64
40814	-	64
40815	-	64
40816	-	64
40817	-	64
40818	-	64
40819	-	64
40820	-	64
40821	-	64
40822	-	64
40823	-	64
40824	-	64
40825	-	64
40826	-	64
40827	-	64
40828	-	64
40829	-	64
40830	-	64
40831	-	64
40832	-	64
40833	-	64
40834	-	64
40835	-	64
40910	-	64
40947	-	64
40836	-	65
40837	-	65
40838	-	65
40839	-	65
40840	-	65
40841	-	65
40842	-	65

Sip. Kod	Fiyat (\$)	Sayfa No
40843	-	66
40844	-	66
40845	-	66
40846	-	66
30500	-	67
30501	-	67
30900	2,23	67
30901	2,23	67
30902	2,36	67
30903	2,58	68
30904	3,44	68
30905	4,00	68
30906	4,93	68
30908	4,76	68
30909	5,56	68
30950	2,32	68
30951	2,40	68
30952	2,80	68
30954	7,07	69
30955	8,55	69
30957	10,77	69
30958	13,24	69
50500	12,40	69
50501	11,50	69
30806	21,29	70
30807	23,96	70
30814	25,08	70
30808	5,46	70
30809	6,52	70
30810	8,25	70
30811	7,99	70
30817	14,11	71
30812	21,32	71
30813	18,50	71
30820	27,37	71
30823	33,06	71
30826	43,32	71
30829	47,88	71
30832	60,00	71
30920	7,00	72
30923	7,50	72
30926	8,00	72
30929	12,00	72

NOT

NOT

NOT

NOT



2005 yılında gaz deşarjlı ve halojen ampullerin satışına odaklanarak çalışmalarımıza başladık. Zamanla gelişen teknolojiye uyum sağlayarak, 2008 yılında ilk LED'li aydınlatma ampulümüzü müşterilerimizle buluşturduk. 2012 yılında UV ampul satışına başlayarak ürün portföyümüze özel ampul grubunu ekledik.

2017 yılında kendi atölyemizde üretime geçerek, yerli üretim LED'li aydınlatma armatürleri sunmaya başladık. 2024 yılında iki model ürünümüz için aldığımız TSE Belgesi, kaliteye ve standartlara verdiğimiz önemin bir göstergesi oldu.

ŞAVK markasıyla sattığımız tüm ürünler için kendi laboratuvarımızda elektriksel güvenlik ve enerji verimliliği testlerini gerçekleştiriyoruz. Ayrıca, ürünlerimiz için TÜRKAK akreditasyonlu laboratuvarlardan alınmış test raporlarımız bulunmaktadır.

Bugün, ŞAVK olarak, aydınlatma alanında ihtiyaçlara uygun, güvenilir ve kaliteli ürünler sunmaya devam ediyoruz.

**Baldem Elektrik Malz. Ltd. Şti.**  
Halkapınar Mah. 1213 Sok. No. 2/E  
35170 Konak, İzmir  
+90 232 459 74 00  
savk@savk.com.tr

